

A photograph of a small, rectangular antenna component is centered in the upper half of the page. The component is black with a thin white border. It is set against a background of white, pyramid-shaped acoustic foam. A horizontal red bar runs across the page below the image.

Antenna Datasheet

Product OC (Antenna Only): YCIS001AA

Product OC (Antenna + Rectangular EVB): YCIS001AAEVB

Version: 2.0

Date: 2023-11-15

Status: Released

Product Name: ISM Ceramic SMD Antenna

Key Features:

Frequency band: 863–870 MHz

Efficiency: Up to 45.9 %

Dimensions: 5 mm × 3 mm × 0.5 mm

RoHS Compliant

Overview

Quectel provides a range of antenna products that support the ISM radio band. These antennas are mounted inside the device to minimize the interference of the devices' internal environment. With the antenna performance and this ensures a better efficiency, gain and omni-directional radiation, offering a superior user experience. Quectel also offers flexible installation with custom cable length and connector options.

Contents

Overview	1
Contents	2
1 Specification	3
1.1. Electrical.....	3
1.2. Mechanical & Environmental	4
2 Drawing	5
2.1. Antenna.....	5
2.2. Rectangular EVB.....	6
3 Detailed Performance	7
3.1. S-Parameter Test	7
3.2.1. VSWR.....	7
3.2.2. Return Loss	8
3.2. Radiation Performance Test.....	9
3.3.1. Efficiency.....	9
3.3.2. Average Gain	10
3.3.3. Peak Gain	11
3.3.4. 3D & 2D Radiation Pattern	12
4 Schematic Symbol and Pin Definition	14
5 Transmission Line	15
6 Recommended PCB Layout	16
7 Matching Circuit	17
8 Soldering Temperature	18
9 Reflow Profile	19
10 Packaging	20
Contact Us	22
Legal Notices	23
Revision History	25

1 Specification

Test Condition: Assembled On 80 mm × 40 mm EVB

1.1. Electrical

Electrical	
Frequency Range	863–870 MHz
Impedance	50 Ω
Polarization	Linear
Radiation Pattern	Omni-directional

Electrical - Detail		
SPEC	Band	ISM 868 MHz
	Band Freq. (MHz)	863-870 MHz
Max VSWR		2.2
Max Return Loss (dB)		-8.7
AVG Eff. (%)		43.0
AVG AVG Gain(dB)		-3.7
Max Peak Gain (dBi)		0.5
VSWR		≤ 2.2
Return Loss		≤ -8.7 dB
Peak Gain		≤ 0.5 dBi

1.2. Mechanical & Environmental

Mechanical	
Antenna Size	5 mm × 3 mm × 0.5 mm
Material & Color	Ceramic & Natural
Antenna Weight	Typ. 0.025 g
Mounting Type	SMD
Recommended EVB Size	Rectangular EVB: 80 × 40 mm
Environmental	
Operation Temperature	-40 °C to +85 °C
Storage Temperature	-40 °C to +85 °C
RoHS Compliant	Yes

2 Drawing

2.1. Antenna

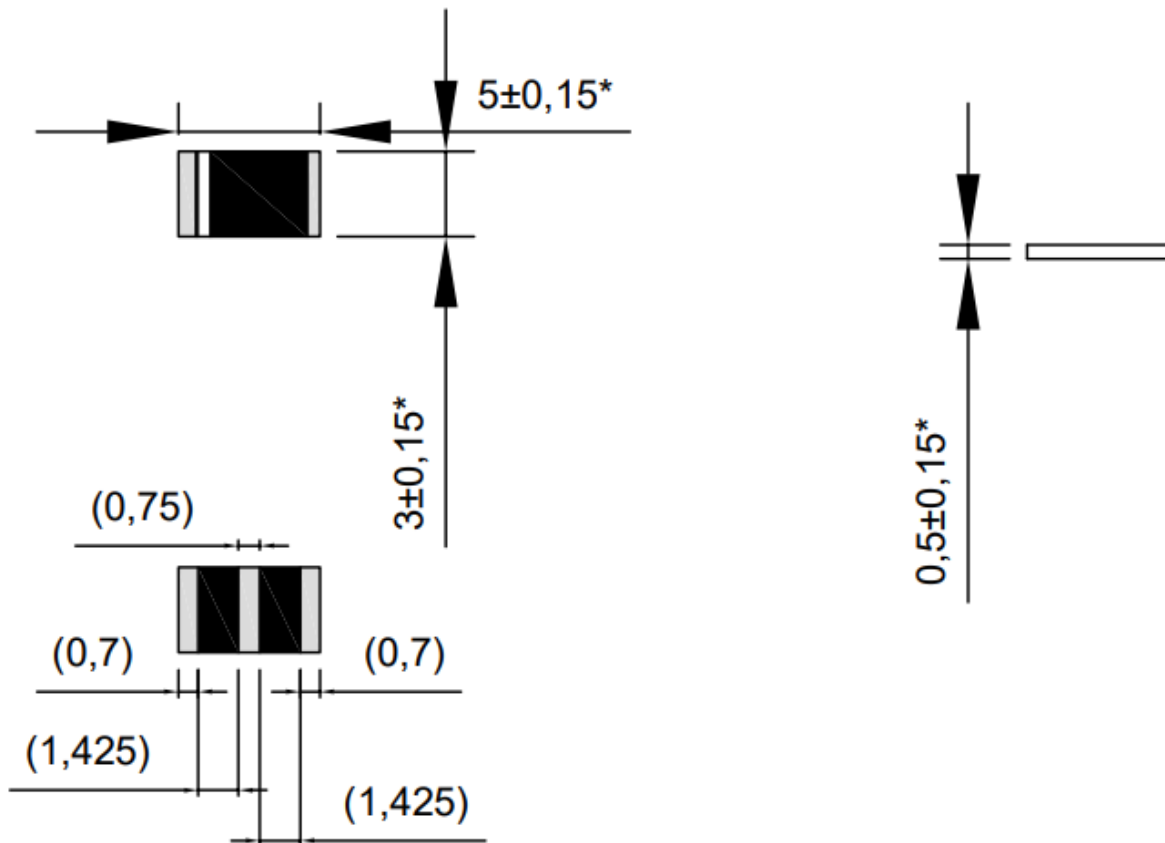

All dimensions are in mm

2.2. Rectangular EVB

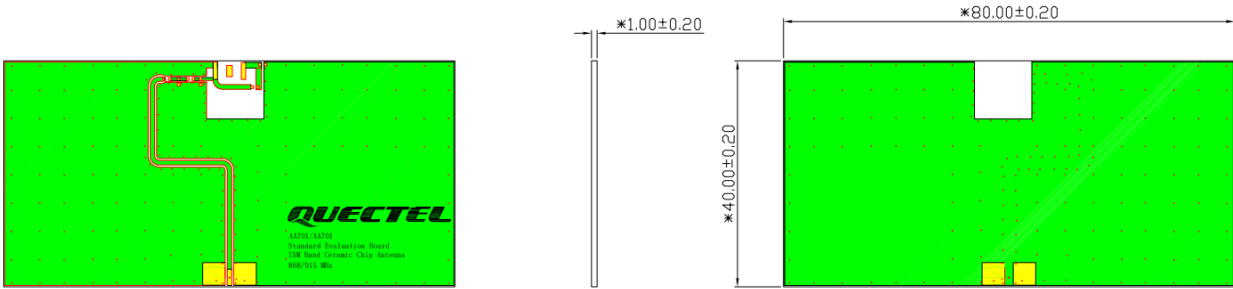

All dimensions are in mm.

3 Detailed Performance

3.1. S-Parameter Test

3.2.1. VSWR

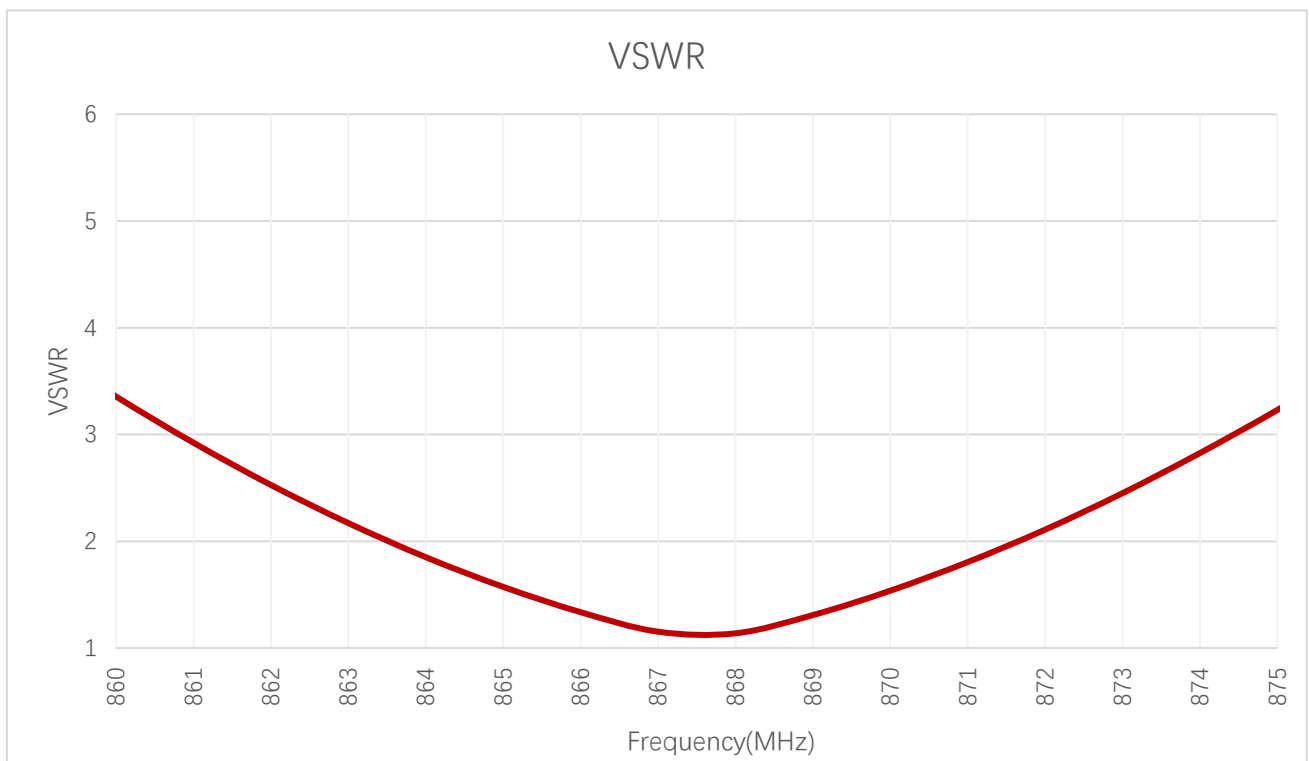

VSWR

Frequency (MHz)	863	868	870
On 80 × 40 mm EVB	2.2	1.1	1.5

3.2.2. Return Loss

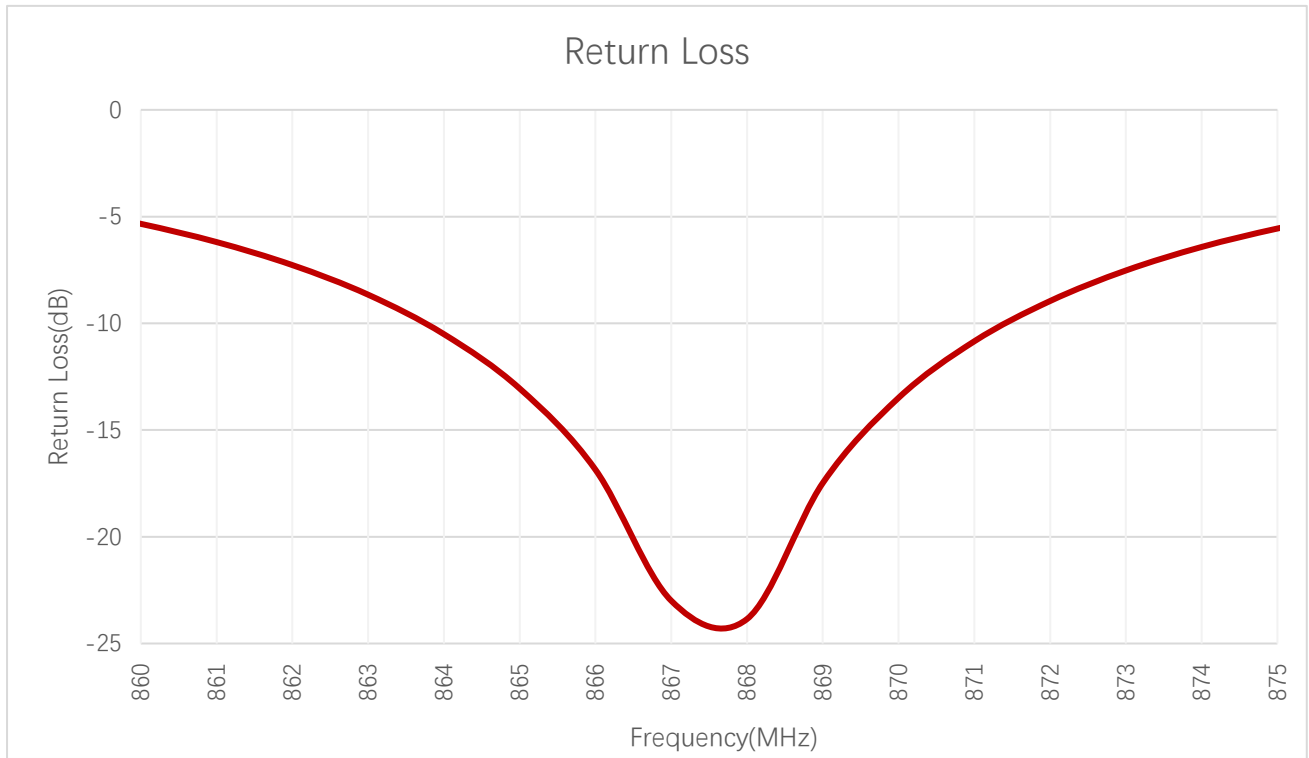

Return Loss (dB)

Frequency (MHz)	863	868	870
On 80 × 40 mm EVB	-8.7	-23.9	-13.5

3.2. Radiation Performance Test

3.3.1. Efficiency

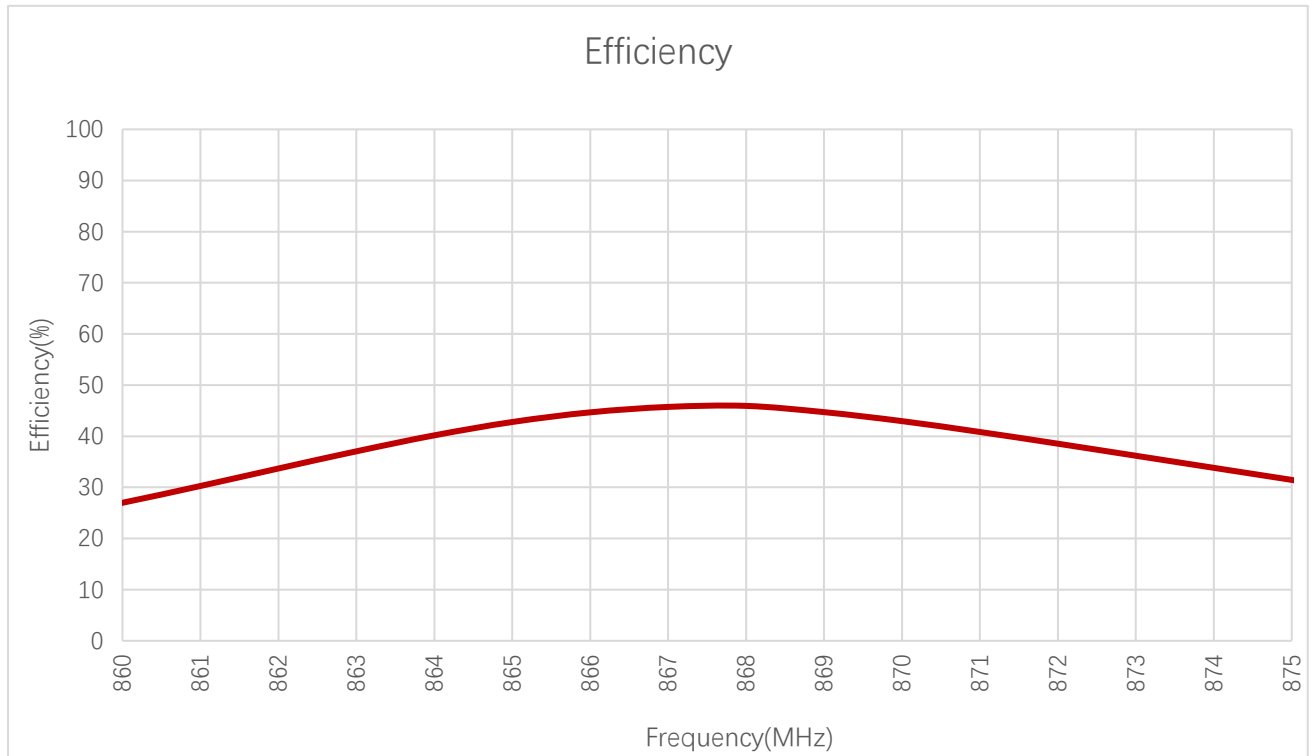

Efficiency (%)

Frequency (MHz)	863	868	870
On 80 × 40 mm EVB	37.1	45.9	43.0

3.3.2. Average Gain

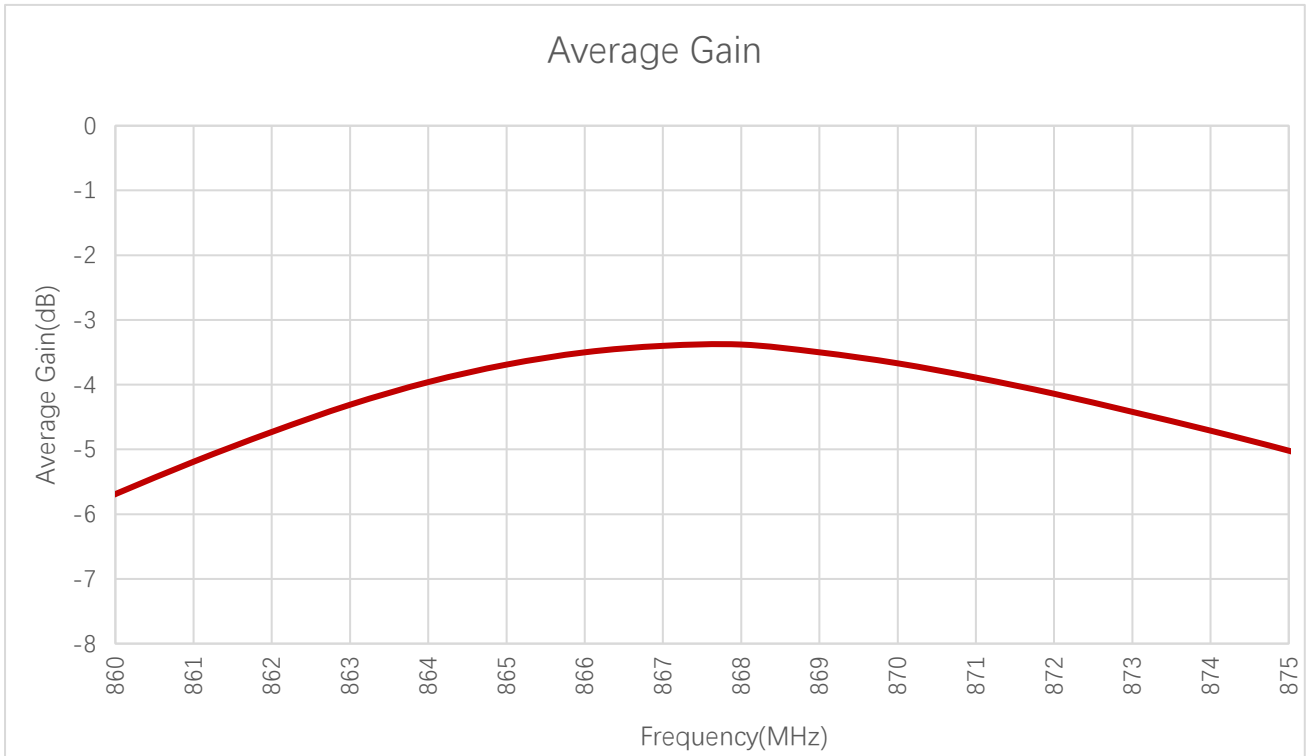

Average Gain (dB)

Frequency (MHz)	863	868	870
On 80 × 40 mm EVB	-4.3	-3.4	-3.7

3.3.3. Peak Gain

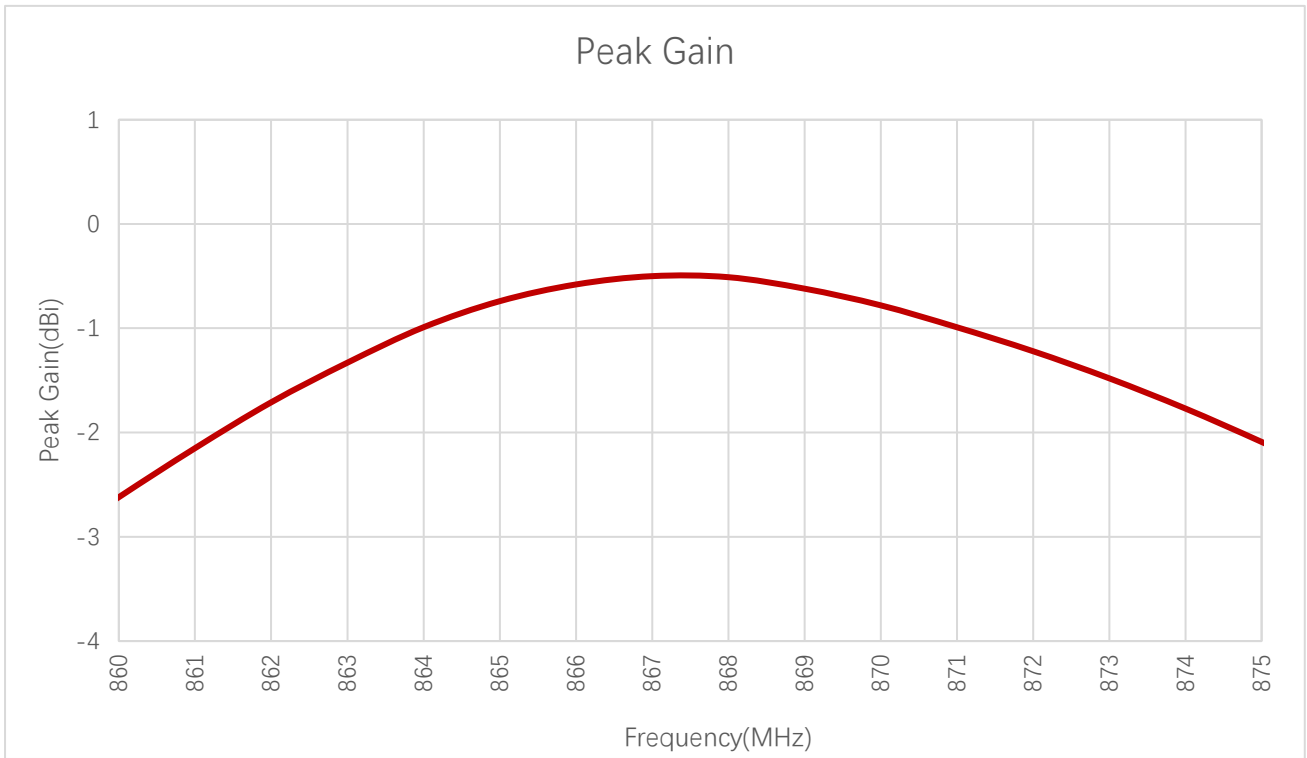

Peak Gain (dBi)

Frequency (MHz)	863	868	870
On 80 × 40 mm EVB	-1.3	-0.5	-0.8

3.3.4. 3D & 2D Radiation Pattern

- Test Status: Assembled on 80 × 40 mm EVB
- Test Chamber: GL-S-1

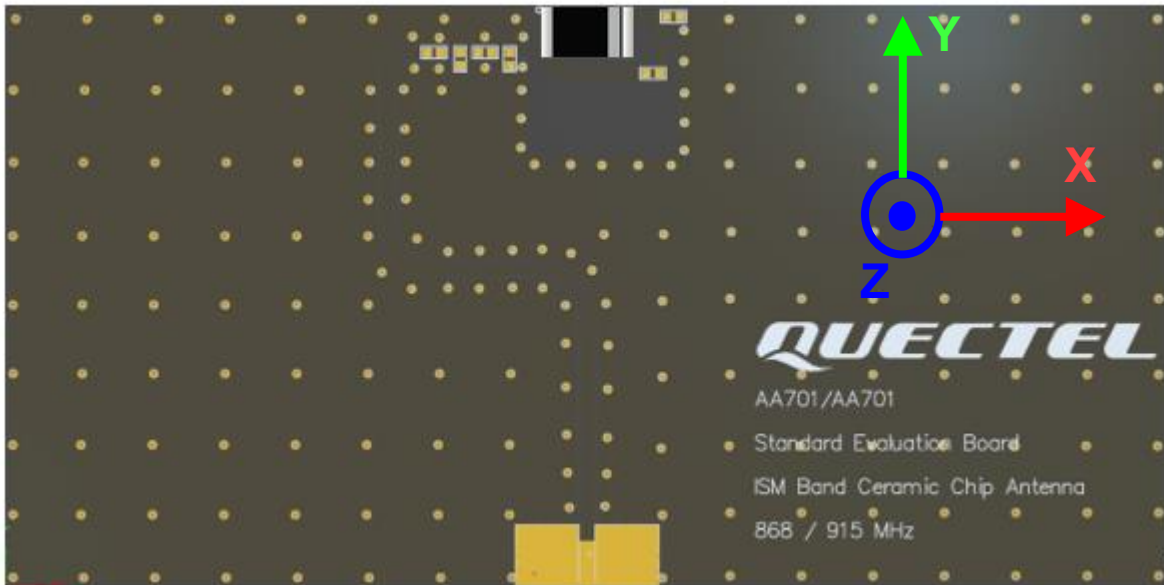

- ISM

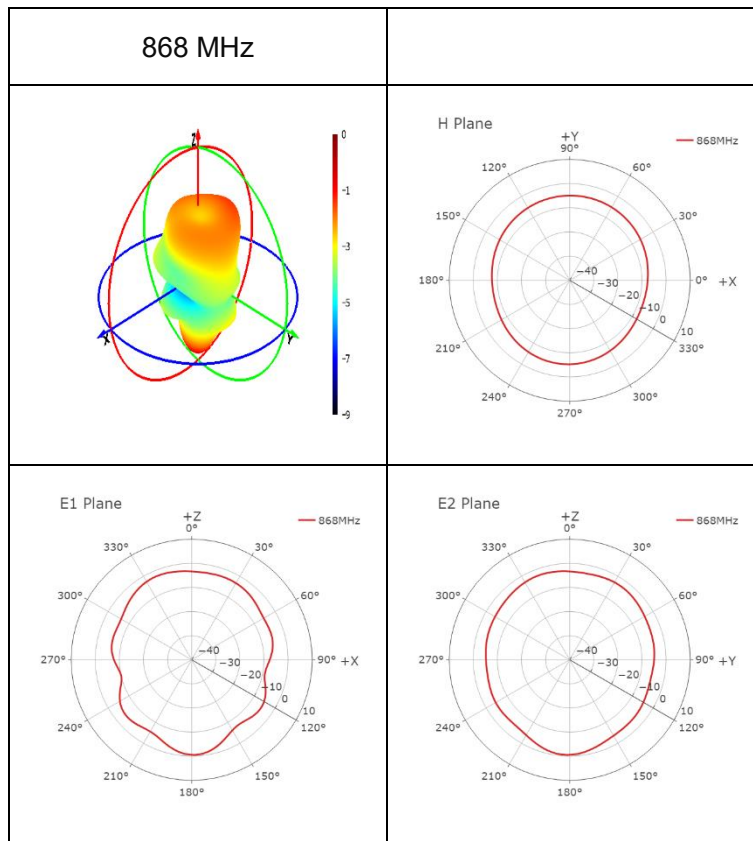

4 Schematic Symbol and Pin Definition

- The pin assignment for the antenna is as follows.
- The circuit symbol for the antenna is shown below. The antenna has 3 pins, only two of which works. All other pins are for mechanical strength.

Pin	Description
1	Return / GND
2	Feed
3	N/C

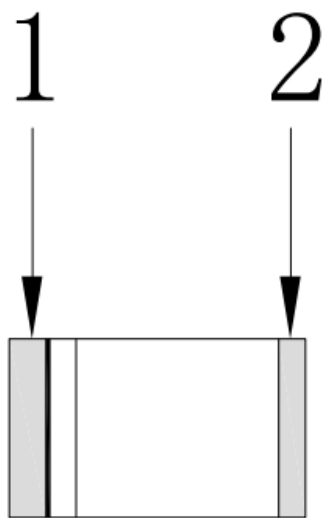

TOP

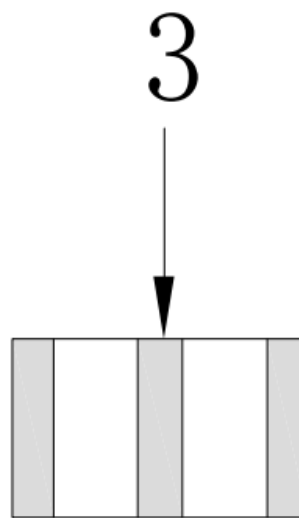

BOTTOM

5 Transmission Line

The characteristic impedance of all transmission lines shall be designed as 50 Ω .

- The length of the transmission lines should be kept as short as possible.
- Any other part of the RF system, such as transceiver, power amplifiers, etc., shall also be designed with an impedance of 50 Ω .

Once the material for the PCB has been chosen (PCB thickness and dielectric constant), a coplanar transmission line can easily be designed using any of the commercial software packages for transmission line design. For the chosen PCB thickness, copper thickness and substrate dielectric constant, the program will calculate the appropriate transmission line width and gaps on either side of the track so the characteristic impedance of the coplanar transmission is 50 Ω .

6 Recommended PCB Layout

The host PCB must be designed using the PCB footprint shown with the correct clearances. An example of the PCB layout shows the antenna footprint. Please note this clearance area is critical to the performance of the antenna and must be applied through all layers of the PCB.

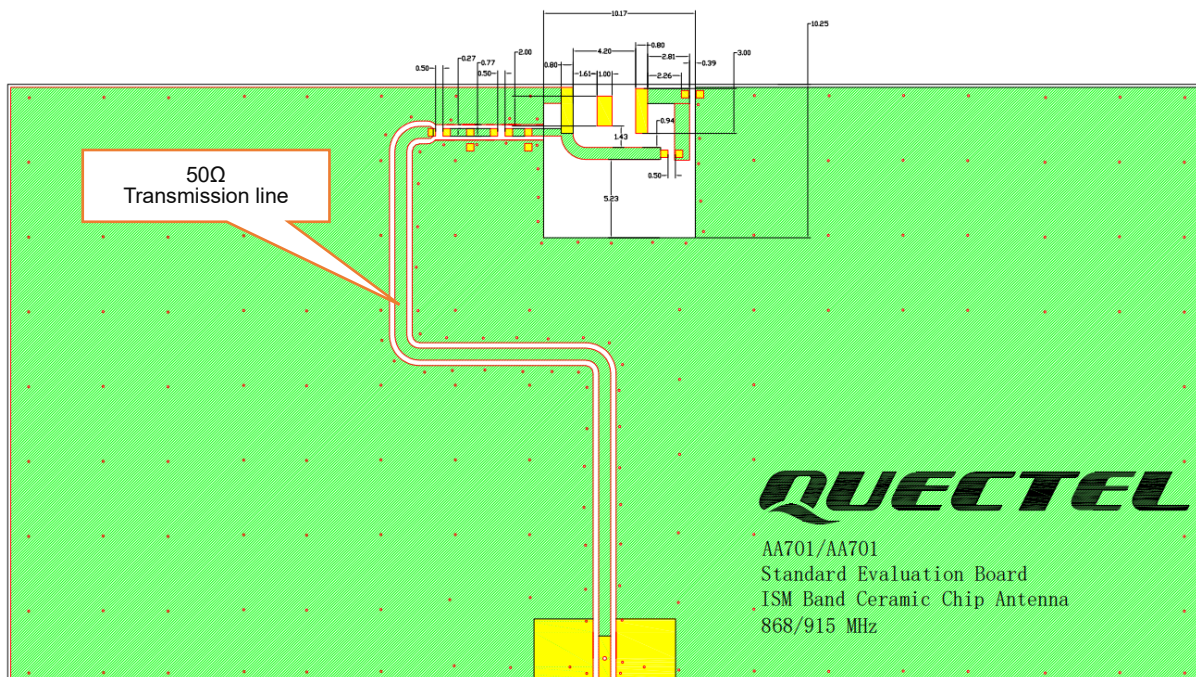

All dimensions are in mm.

7 Matching Circuit

Demo Board Top View

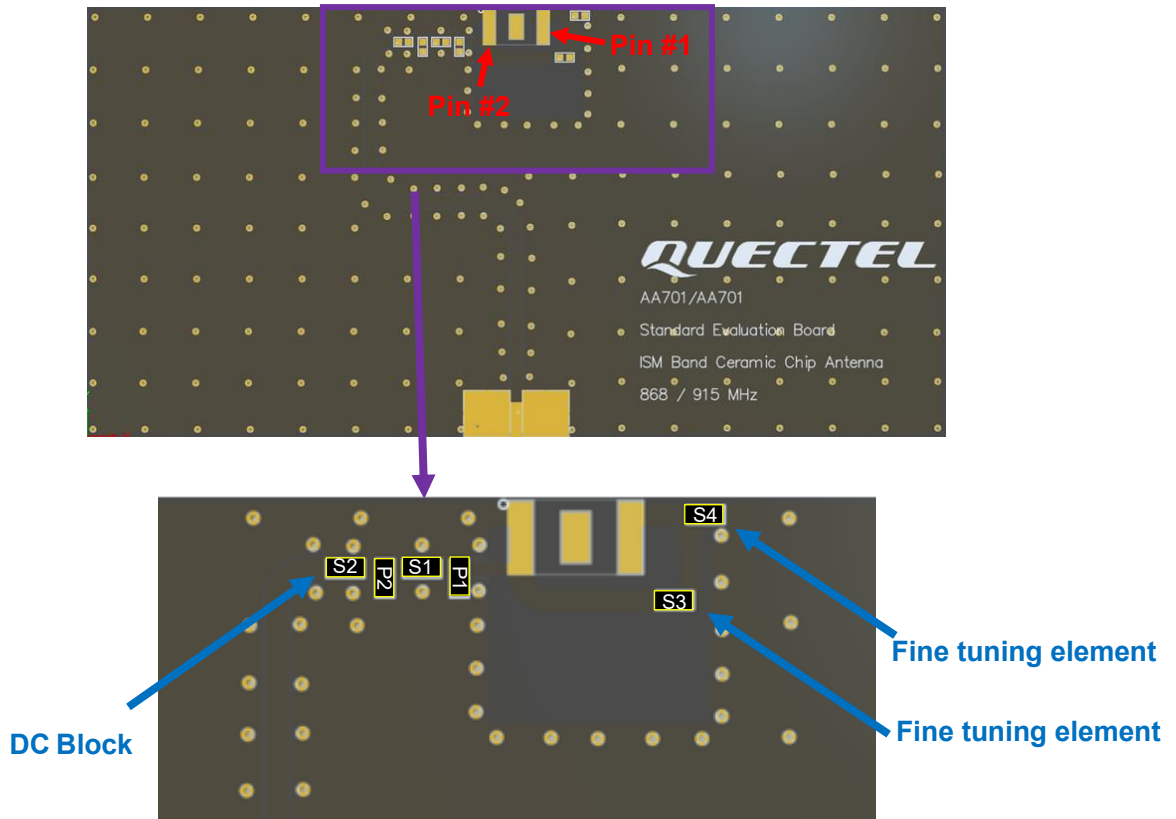

Matching circuit: (Center frequency is about 868 MHz at @ 80 × 40 mm Evaluation Board)

	P1	S1	P2	S2	S3	S4
Default Matching	N/A	0Ω	12nH	22pF	2.7pF	2.7pF
Tolerance	N/A	/	±5%	±0.05pF	±0.05pF	±0.05pF

Pin #	Description
1	Return / GND
2	Feed

8 Soldering Temperature

Phase	Profile Features	PB-Free Assembly
RAMP-UP	Avg. Ramp-up Rate (T _{smax} to T _p)	3 °C/second (Max.)
PREHEAT	Temperature Min (T _{smin}) Temperature Max (T _{smax}) Time (t _{smin} to t _{smax})	150 °C 190 °C 110 seconds (Max.)
REFLOW	Temperature (TL) Total Time above TL (tl)	220 °C 90 seconds (Max.)
PEAK	Temperature (T _p)	230–250 °C
RAMP-DOWN	Rate	-1 °C/second (Max.)

9 Reflow Profile

Solder paste alloy: SAC305 (Sn96.5/Ag3/Cu0.5) Lead Free solder paste

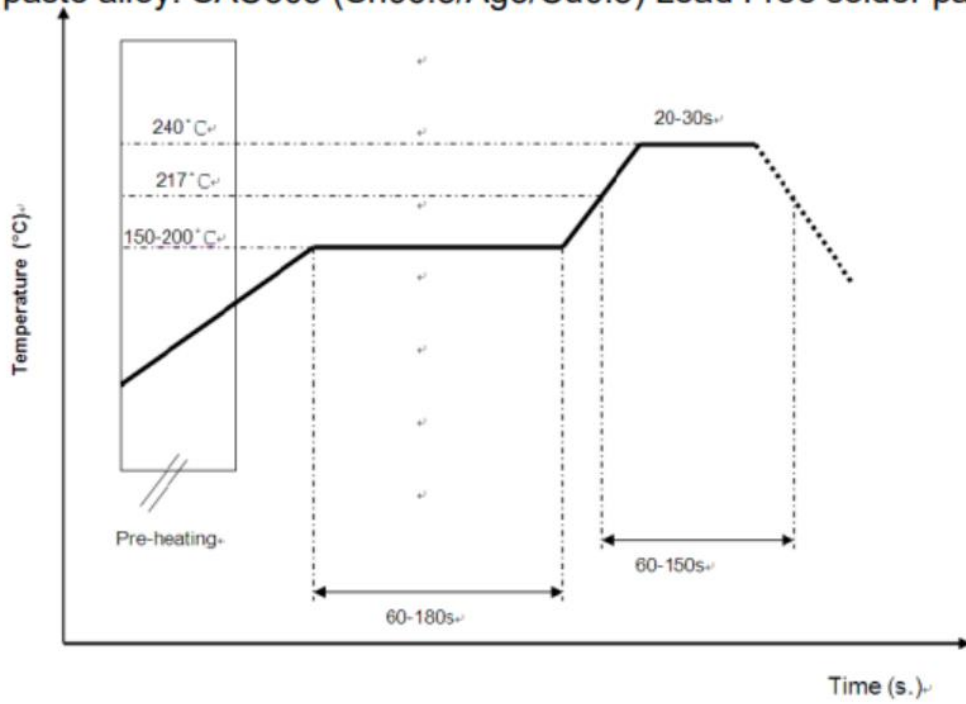

*Recommended solder paste alloy: SAC305 (Sn96.5 /Ag3 /Cu0.5) Lead Free solder paste.

10 Packaging

Step	Packaging Picture / 2D Picture	Description
1		Reel
2		<p>(5000 PCS Antenna Products / Reel) Put 3 reels into the inner box.</p>
3		<p>(12 Inner Boxes / Carton Box) (180000 PCS Antennas / Carton Box) Estimated quantity Products that cannot fill the entire carton box are packed in a suitable size carton box. <u>Carton Size:</u> <u>L × W × H = 400 × 400 × 200 mm</u></p>

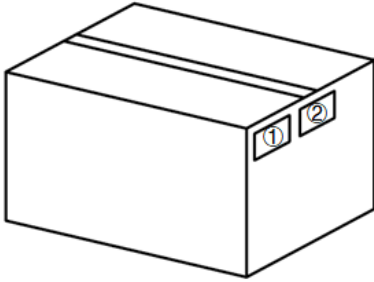
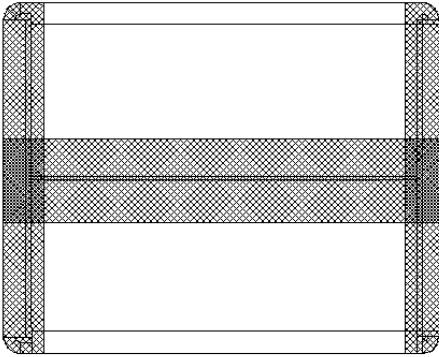
<p>4</p>		<p>Position for Attaching Labels</p> <p>① Carton Label ② Quality Label</p>
<p>5</p>		<p>Sealing Cartons</p> <p>“I” type sealing cartons</p>
<p>6</p>	<p>The initial packaging method described above is for reference only, and the final actual packaging method shall be subject to the actual shipping packaging.</p>	

Contact Us

At Quectel, our aim is to provide timely and comprehensive services to our customers. If you require any assistance, please contact our headquarters:

Quectel Wireless Solutions Co., Ltd.

Building 5, Shanghai Business Park Phase III (Area B), No.1016 Tianlin Road, Minhang District, Shanghai 200233, China

Tel: +86 21 5108 6236

Email: info@quectel.com

Or our local offices. For more information, please visit:

<http://www.quectel.com/support/sales.htm>.

For technical support, or to report documentation errors, please visit:

<http://www.quectel.com/support/technical.htm>.

Or email us at: support@quectel.com.

Legal Notices

We offer information as a service to you. The provided information is based on your requirements and we make every effort to ensure its quality. You agree that you are responsible for using independent analysis and evaluation in designing intended products, and we provide reference designs for illustrative purposes only. Before using any hardware, software or service guided by this document, please read this notice carefully. Even though we employ commercially reasonable efforts to provide the best possible experience, you hereby acknowledge and agree that this document and related services hereunder are provided to you on an “as available” basis. We may revise or restate this document from time to time at our sole discretion without any prior notice to you.

Use and Disclosure Restrictions

License Agreements

Documents and information provided by us shall be kept confidential, unless specific permission is granted. They shall not be accessed or used for any purpose except as expressly provided herein.

Copyright

Our and third-party products hereunder may contain copyrighted material. Such copyrighted material shall not be copied, reproduced, distributed, merged, published, translated, or modified without prior written consent. We and the third party have exclusive rights over copyrighted material. No license shall be granted or conveyed under any patents, copyrights, trademarks, or service mark rights. To avoid ambiguities, purchasing in any form cannot be deemed as granting a license other than the normal non-exclusive, royalty-free license to use the material. We reserve the right to take legal action for noncompliance with abovementioned requirements, unauthorized use, or other illegal or malicious use of the material.

Trademarks

Except as otherwise set forth herein, nothing in this document shall be construed as conferring any rights to use any trademark, trade name or name, abbreviation, or counterfeit product thereof owned by Quectel or any third party in advertising, publicity, or other aspects.

Third-Party Rights

This document may refer to hardware, software and/or documentation owned by one or more third parties (“third-party materials”). Use of such third-party materials shall be governed by all restrictions and obligations applicable thereto.

We make no warranty or representation, either express or implied, regarding the third-party materials, including but not limited to any implied or statutory, warranties of merchantability or fitness for a particular purpose, quiet enjoyment, system integration, information accuracy, and non-infringement of any third-party intellectual property rights with regard to the licensed technology or use thereof. Nothing herein constitutes a representation or warranty by us to either develop, enhance, modify, distribute, market, sell, offer for sale, or otherwise maintain production of any our products or any other hardware, software, device, tool, information, or product. We moreover disclaim any and all warranties arising from the course of dealing or usage of trade.

Privacy Policy

To implement module functionality, certain device data are uploaded to Quectel's or third-party's servers, including carriers, chipset suppliers or customer-designated servers. Quectel, strictly abiding by the relevant laws and regulations, shall retain, use, disclose or otherwise process relevant data for the purpose of performing the service only or as permitted by applicable laws. Before data interaction with third parties, please be informed of their privacy and data security policy.

Disclaimer

- a) We acknowledge no liability for any injury or damage arising from the reliance upon the information.
- b) We shall bear no liability resulting from any inaccuracies or omissions, or from the use of the information contained herein.
- c) While we have made every effort to ensure that the functions and features under development are free from errors, it is possible that they could contain errors, inaccuracies, and omissions. Unless otherwise provided by valid agreement, we make no warranties of any kind, either implied or express, and exclude all liability for any loss or damage suffered in connection with the use of features and functions under development, to the maximum extent permitted by law, regardless of whether such loss or damage may have been foreseeable.
- d) We are not responsible for the accessibility, safety, accuracy, availability, legality, or completeness of information, advertising, commercial offers, products, services, and materials on third-party websites and third-party resources.

Copyright © Quectel Wireless Solutions Co., Ltd. 2023. All rights reserved.

Revision History

Version	Date	Author	Note
-	2022-04-28	Junsen LI/ Joye WANG	Creation of the document
1.0	2022-04-28	Junsen LI/ Joye WANG	First official release
1.1	2022-09-20	Junsen LI	Added Chapter 6.
2.0	2023-11-15	Nico PAN/ Lucky FENG/ David LIU/ Vinnie LIU	Numerous changes were made to this document. It should be read in its entirety.

QUECTEL

www.quectel.com