



# Antenna Datasheet

**Product OC:** YE0011BA

**Version:** 2.0

**Date:** 2023-04-27

**Status:** Released

**Product Name:** 4G External Antenna

**Key Features:**

Frequency Band: 700–960 MHz, 1710–2170 MHz

Dimensions:  $\Phi$  10.5 × 50 × 16.4 mm

Efficiency: Up to 79.95 %

RoHS Compliant

IP53

# Overview

This Quectel external 4G antenna covers main 4G LTE bands and is compatible with 3G/2G/LPWA bands as well. The external antenna is barely influenced by the internal environment of devices, giving a much better performance in efficiency, radiation and gain whilst providing an optimized solution for a customer product. Quectel also offers flexible installation with custom cable length and connector options.

# Contents

Overview.....	1
Contents.....	2
<b>1 Specification.....</b>	<b>3</b>
1.1. Electrical.....	3
1.2. Mechanical, Environmental & Storage.....	4
<b>2 Drawing.....</b>	<b>5</b>
<b>3 Detailed Performance.....</b>	<b>6</b>
3.1. S-Parameter Test.....	6
3.1.1. VSWR.....	6
3.1.2. Return Loss.....	7
3.2. Radiation Performance Test.....	8
3.2.1. Efficiency.....	8
3.2.2. Average Gain.....	9
3.2.3. Peak Gain.....	10
3.2.4. 3D & 2D Radiation Pattern.....	11
3.2.4.1. Test Condition: On 130 × 130 mm EVB.....	11
<b>4 Packaging.....</b>	<b>14</b>
Contact Us.....	16
Legal Notices.....	17
Revision History.....	19

# 1 Specification

Test Condition: On 130 × 130 mm EVB

## 1.1. Electrical

Electrical	
Frequency Range	700–960 MHz, 1710–2170 MHz
Impedance	50 Ω
Polarization	Linear
Radiation Pattern	Omni-directional

Electrical - Detail												
SPEC	Band	B71	B12 /B13 /B28	B5 /B8 /B26	N74 /N75 /N76	B1 /B2 /B3	B40	Wi-Fi 2G	B38 /B41	B42 /B48 /N77	N79	Wi-Fi 5G
	Band Freq. (MHz)	600– 700	700– 810	820– 960	1420– 1520	1700– 2170	2300– 2400	2400– 2500	2500– 2690	3300– 4200	4400– 5000	5150– 5850
Max. VSWR	-	3.5	9.3	-	3.1	-	-	-	-	-	-	-
Max. Return Loss (dB)	-	-5.1	-1.9	-	-5.7	-	-	-	-	-	-	-
AVG Eff. (%)	-	71.6	50.9	-	61.3	-	-	-	-	-	-	-
AVG Gain (dB)	-	-1.5	-3.1	-	-2.1	-	-	-	-	-	-	-
Max. Peak Gain (dBi)	-	2.7	2.6	-	1.5	-	-	-	-	-	-	-
VSWR	≤ 9.3											
Return Loss	≤ -1.9 dB											
Peak Gain	≤ 2.7 dBi											

## 1.2. Mechanical, Environmental & Storage

Mechanical	
Antenna Dimensions	Φ 10.5 × 50 × 16.4 mm
Casing Material & Color	TPEE & Black
Connector Type	SMA Male
Mounting Type	Terminal
Weight	Typ. 6 g
Environmental	
Operation Temperature	-40 °C to +85 °C
RoHS Compliant	Yes
IP Rating	IP53

Storage	
Storage Temperature	18 °C–27 °C
Humidity	30 %–80 % RH
Storage Place	Away from corrosive gas and direct sunlight.
Packaging	Antennas should be stored in unopened sealed manufacturer's plastic packaging.

# 2 Drawing

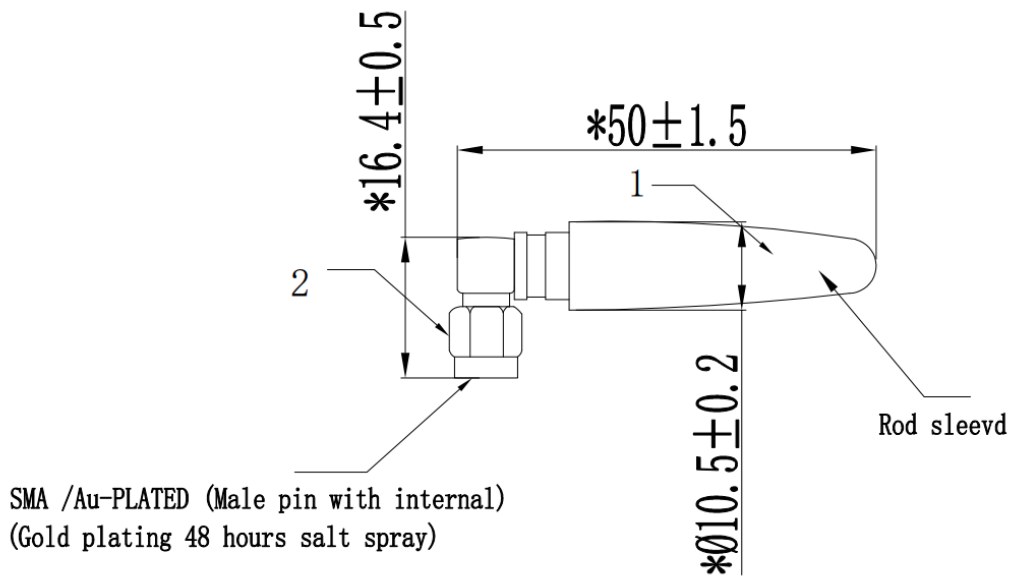

# 3 Detailed Performance

## 3.1. S-Parameter Test

### 3.1.1. VSWR

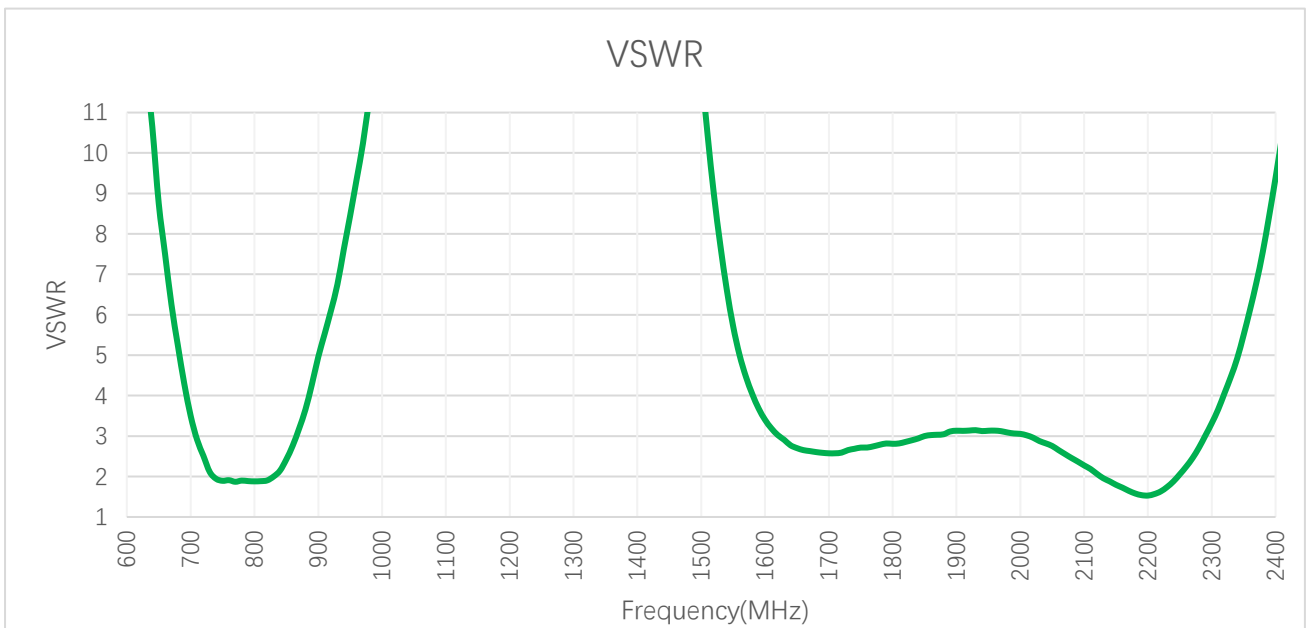

**VSWR**

Frequency (MHz)	600	630	710	830	900	960	1440	1710	1740	1880
VSWR	-	-	2.9	2.0	5.0	9.3	-	2.6	2.7	3.0
Frequency (MHz)	1950	2140	2350	2450	2600	3600	4000	4700	5500	6000
VSWR	3.1	1.9	-	-	-	-	-	-	-	-

**3.1.2. Return Loss**

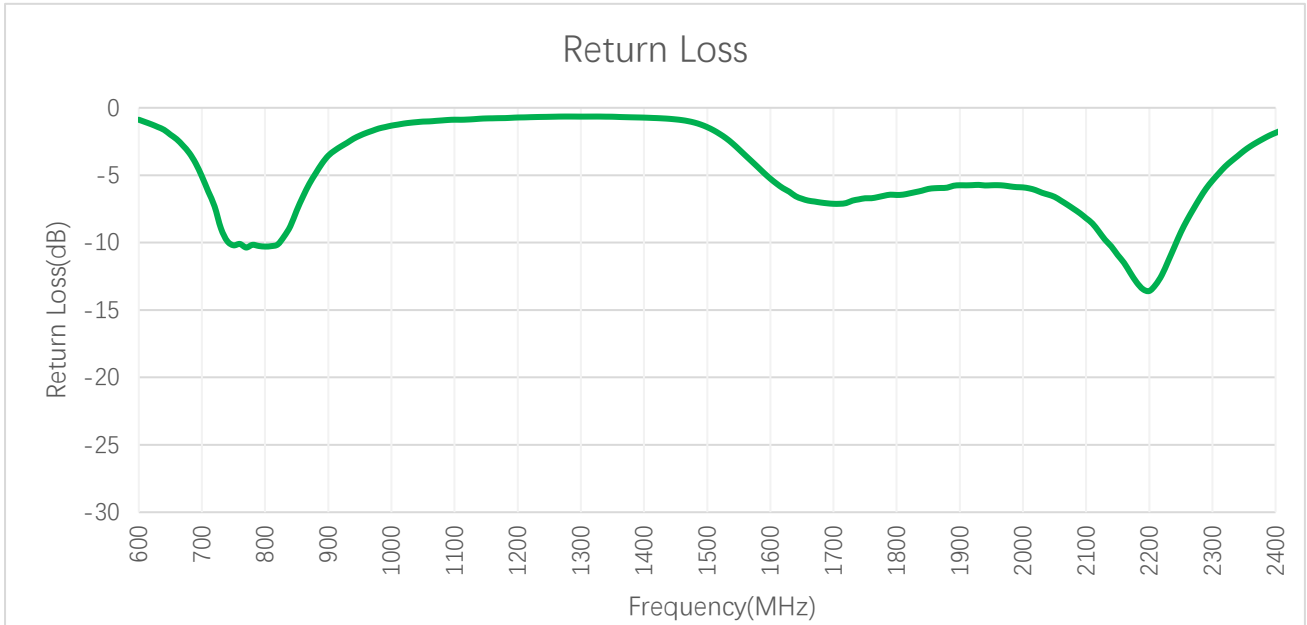

**Return Loss (dB)**

<b>Frequency (MHz)</b>	<b>600</b>	<b>630</b>	<b>710</b>	<b>830</b>	<b>900</b>	<b>960</b>	<b>1440</b>	<b>1710</b>	<b>1740</b>	<b>1880</b>
<b>Return Loss (dB)</b>	-	-	-6.2	-9.5	-3.6	-1.9	-	-7.1	-6.8	-5.9
<b>Frequency (MHz)</b>	<b>1950</b>	<b>2140</b>	<b>2350</b>	<b>2450</b>	<b>2600</b>	<b>3600</b>	<b>4000</b>	<b>4700</b>	<b>5500</b>	<b>6000</b>
<b>Return Loss (dB)</b>	-5.7	-10.3	-	-	-	-	-	-	-	-



### 3.2. Radiation Performance Test

#### 3.2.1. Efficiency

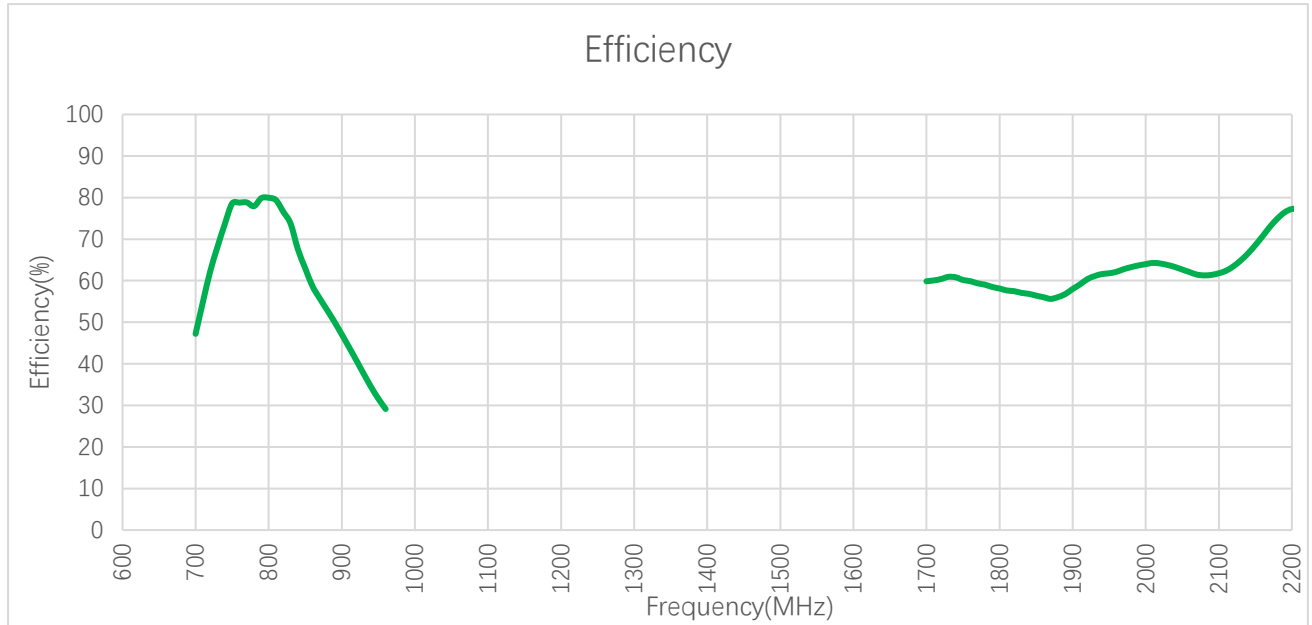

**Efficiency (%)**

<b>Frequency (MHz)</b>	<b>600</b>	<b>630</b>	<b>710</b>	<b>830</b>	<b>900</b>	<b>960</b>	<b>1440</b>	<b>1710</b>	<b>1740</b>	<b>1880</b>
<b>Efficiency (%)</b>	-	-	54.9	73.7	47.1	29.1	-	60.1	60.8	56.1
<b>Frequency (MHz)</b>	<b>1950</b>	<b>2140</b>	<b>2350</b>	<b>2450</b>	<b>2600</b>	<b>3600</b>	<b>4000</b>	<b>4700</b>	<b>5500</b>	<b>6000</b>
<b>Efficiency (%)</b>	61.8	66.6	-	-	-	-	-	-	-	-

**3.2.2. Average Gain**

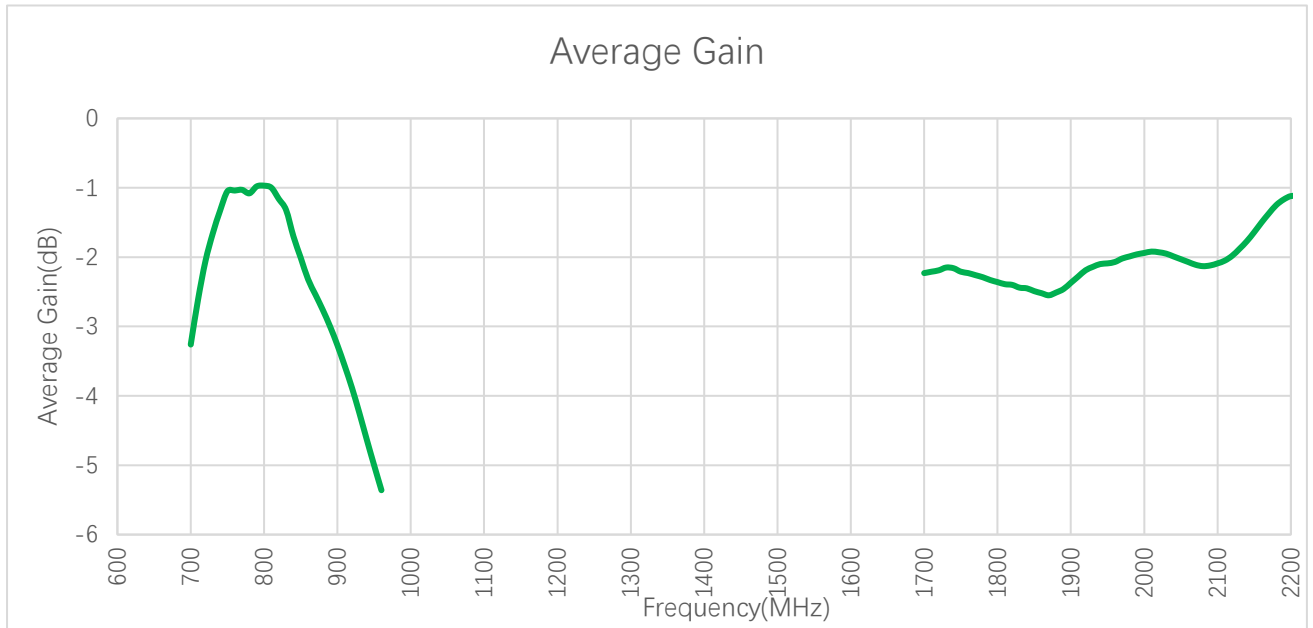

**Average Gain (dB)**

<b>Frequency (MHz)</b>	<b>600</b>	<b>630</b>	<b>710</b>	<b>830</b>	<b>900</b>	<b>960</b>	<b>1440</b>	<b>1710</b>	<b>1740</b>	<b>1880</b>
<b>Average Gain (dB)</b>	-	-	-2.6	-1.3	-3.3	-5.4	-	-2.2	-2.2	-2.5
<b>Frequency (MHz)</b>	<b>1950</b>	<b>2140</b>	<b>2350</b>	<b>2450</b>	<b>2600</b>	<b>3600</b>	<b>4000</b>	<b>4700</b>	<b>5500</b>	<b>6000</b>
<b>Average Gain (dB)</b>	-2.1	-1.8	-	-	-	-	-	-	-	-

**3.2.3. Peak Gain**

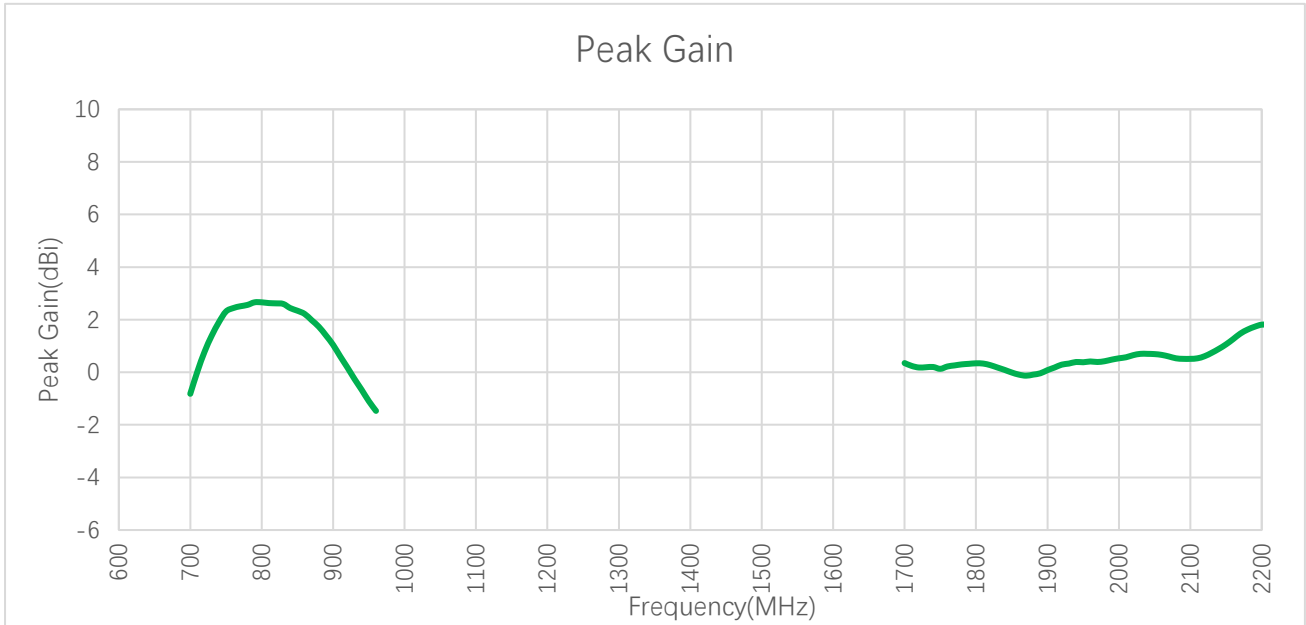

**Peak Gain (dBi)**

<b>Frequency (MHz)</b>	<b>600</b>	<b>630</b>	<b>710</b>	<b>830</b>	<b>900</b>	<b>960</b>	<b>1440</b>	<b>1710</b>	<b>1740</b>	<b>1880</b>
<b>Peak Gain (dBi)</b>	-	-	0.0	2.6	1.0	-1.5	-	0.2	0.2	-0.1
<b>Frequency (MHz)</b>	<b>1950</b>	<b>2140</b>	<b>2350</b>	<b>2450</b>	<b>2600</b>	<b>3600</b>	<b>4000</b>	<b>4700</b>	<b>5500</b>	<b>6000</b>
<b>Peak Gain (dBi)</b>	0.4	0.9	-	-	-	-	-	-	-	-

### 3.2.4. 3D & 2D Radiation Pattern

#### 3.2.4.1. Test Condition: On 130 × 130 mm EVB

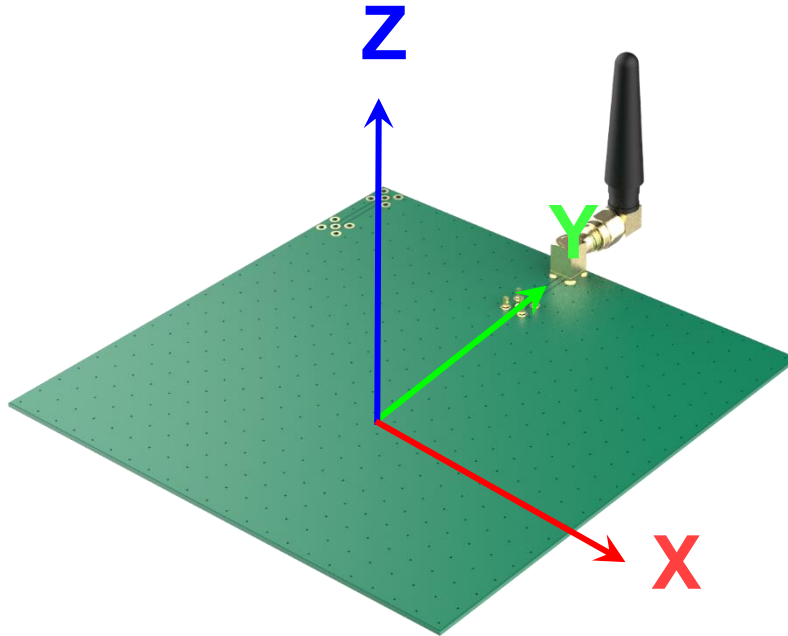

- Test Chamber: GL-S-1

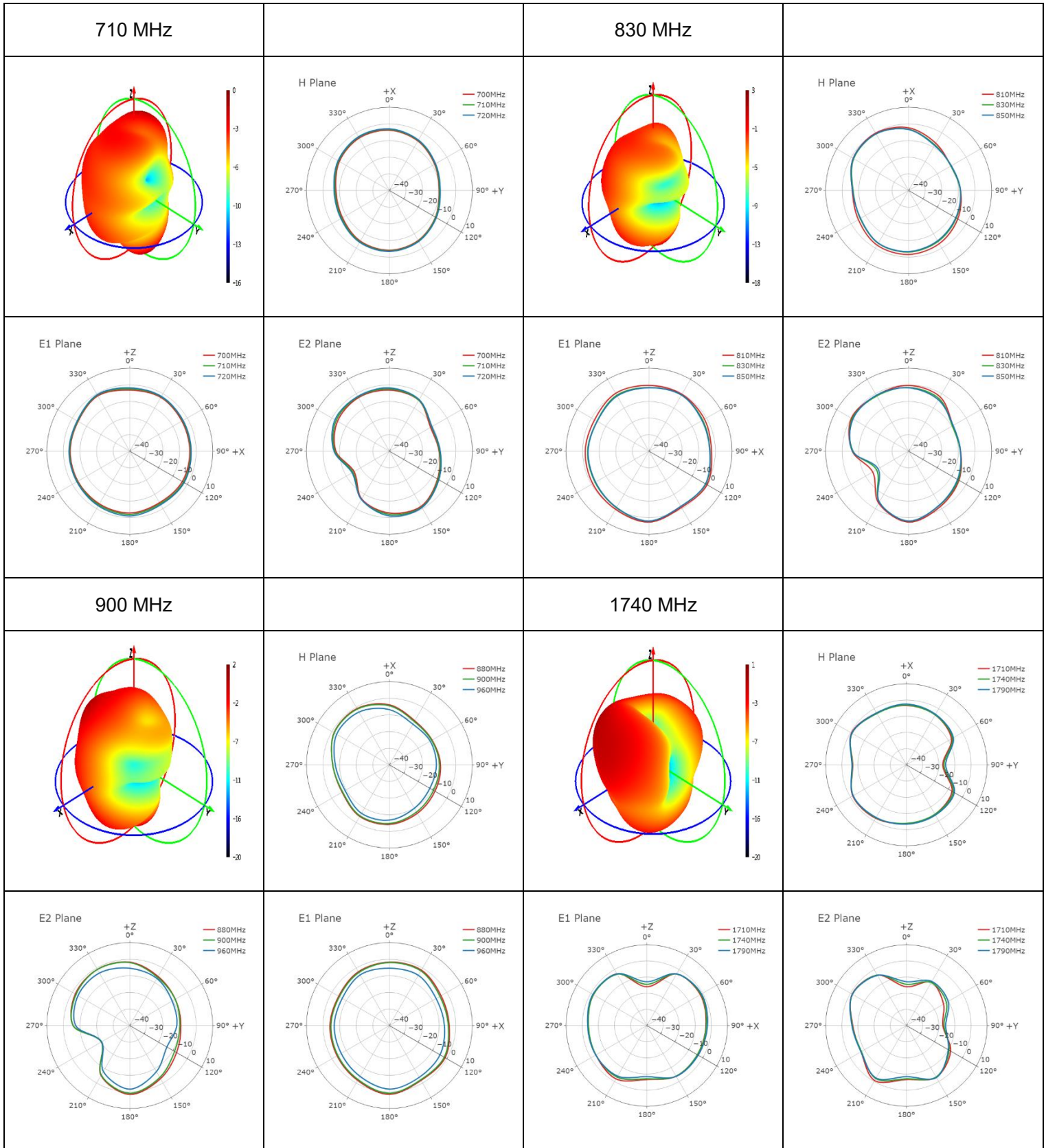

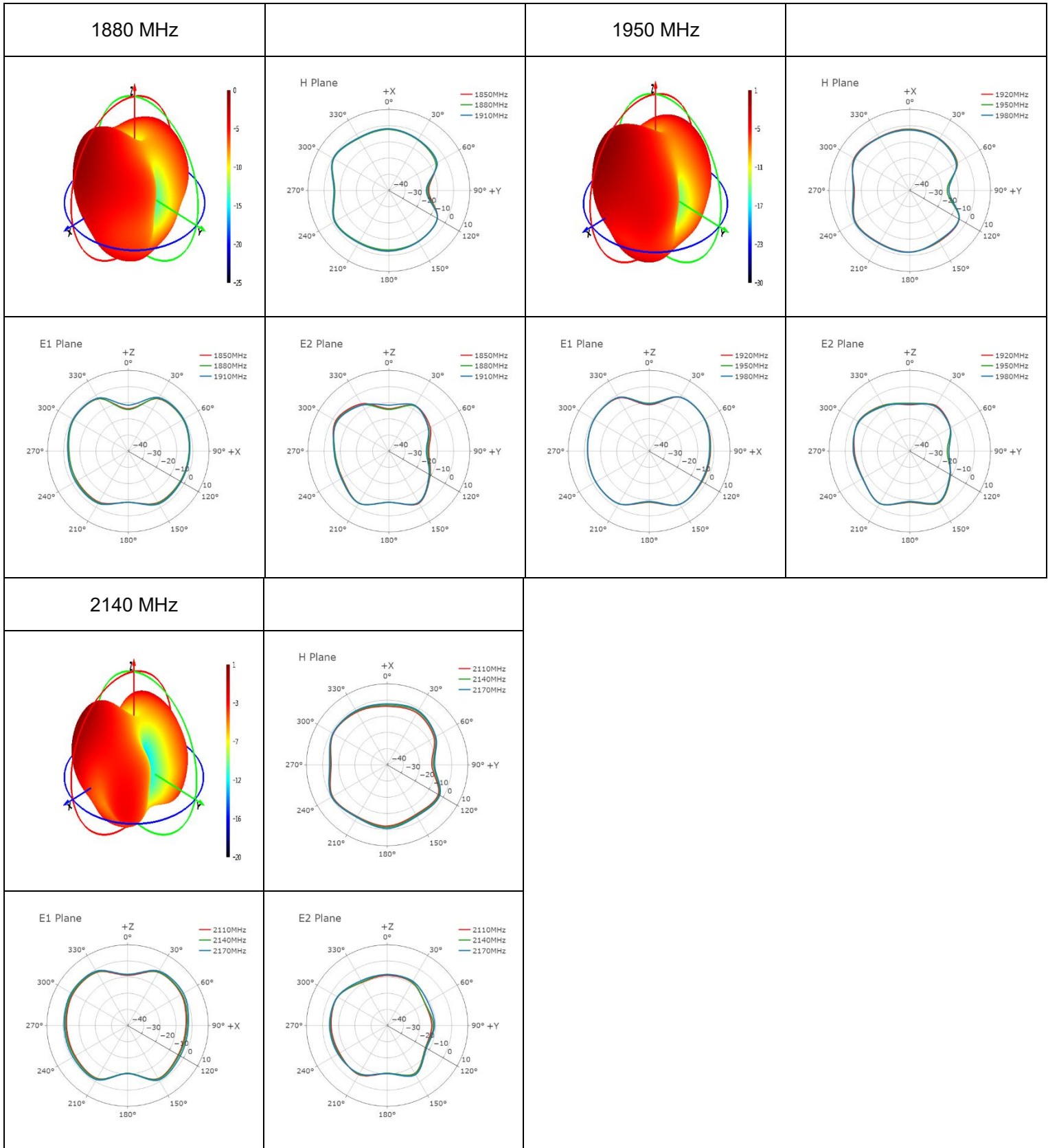

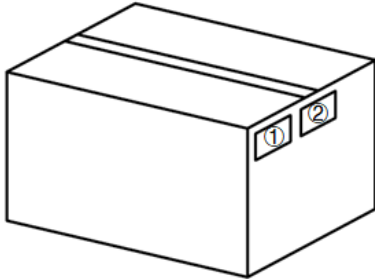

# 4 Packaging

Step	Packaging Picture / 2D Picture	Description
1		<p>200 pcs antenna products in a PE bag; (200 pcs antennas per PE bag)</p>
2		<p>(9 PE bags per carton box) (1800 pcs antennas per carton box)</p> <p><u>Carton Size:</u> <u>L × W × H = 405 × 293 × 185 mm</u></p>
3		<p><b>Position for Attaching Labels</b></p> <p>① Carton Label ② Quality Label</p>

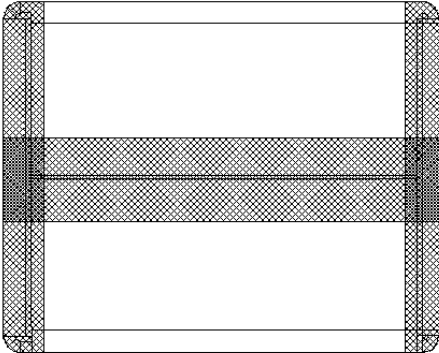
4		<p><b>Sealing Cartons</b> “I” type sealing cartons</p>
---	---	--



# Contact Us

**At Quectel, our aim is to provide timely and comprehensive services to our customers. If you require any assistance, please contact our headquarters:**

**Quectel Wireless Solutions Co., Ltd.**

Building 5, Shanghai Business Park Phase III (Area B), No.1016 Tianlin Road, Minhang District, Shanghai 200233, China

Tel: +86 21 5108 6236

Email: [info@quectel.com](mailto:info@quectel.com)

**Or our local offices. For more information, please visit:**

<http://www.quectel.com/support/sales.htm>.

**For technical support, or to report documentation errors, please visit:**

<http://www.quectel.com/support/technical.htm>.

Or email us at: [support@quectel.com](mailto:support@quectel.com).

# Legal Notices

We offer information as a service to you. The provided information is based on your requirements and we make every effort to ensure its quality. You agree that you are responsible for using independent analysis and evaluation in designing intended products, and we provide reference designs for illustrative purposes only. Before using any hardware, software or service guided by this document, please read this notice carefully. Even though we employ commercially reasonable efforts to provide the best possible experience, you hereby acknowledge and agree that this document and related services hereunder are provided to you on an “as available” basis. We may revise or restate this document from time to time at our sole discretion without any prior notice to you.

## Use and Disclosure Restrictions

### License Agreements

Documents and information provided by us shall be kept confidential, unless specific permission is granted. They shall not be accessed or used for any purpose except as expressly provided herein.

### Copyright

Our and third-party products hereunder may contain copyrighted material. Such copyrighted material shall not be copied, reproduced, distributed, merged, published, translated, or modified without prior written consent. We and the third party have exclusive rights over copyrighted material. No license shall be granted or conveyed under any patents, copyrights, trademarks, or service mark rights. To avoid ambiguities, purchasing in any form cannot be deemed as granting a license other than the normal non-exclusive, royalty-free license to use the material. We reserve the right to take legal action for noncompliance with abovementioned requirements, unauthorized use, or other illegal or malicious use of the material.

### Trademarks

Except as otherwise set forth herein, nothing in this document shall be construed as conferring any rights to use any trademark, trade name or name, abbreviation, or counterfeit product thereof owned by Quectel or any third party in advertising, publicity, or other aspects.

### Third-Party Rights

This document may refer to hardware, software and/or documentation owned by one or more third parties (“third-party materials”). Use of such third-party materials shall be governed by all restrictions and obligations applicable thereto.

We make no warranty or representation, either express or implied, regarding the third-party materials, including but not limited to any implied or statutory, warranties of merchantability or fitness for a particular purpose, quiet enjoyment, system integration, information accuracy, and non-infringement of any third-party intellectual property rights with regard to the licensed technology or use thereof. Nothing herein constitutes a representation or warranty by us to either develop, enhance, modify, distribute, market, sell, offer for sale, or otherwise maintain production of any our products or any other hardware, software, device, tool, information, or product. We moreover disclaim any and all warranties arising from the course of dealing or usage of trade.

## Privacy Policy

To implement module functionality, certain device data are uploaded to Quectel's or third-party's servers, including carriers, chipset suppliers or customer-designated servers. Quectel, strictly abiding by the relevant laws and regulations, shall retain, use, disclose or otherwise process relevant data for the purpose of performing the service only or as permitted by applicable laws. Before data interaction with third parties, please be informed of their privacy and data security policy.

## Disclaimer

- a) We acknowledge no liability for any injury or damage arising from the reliance upon the information.
- b) We shall bear no liability resulting from any inaccuracies or omissions, or from the use of the information contained herein.
- c) While we have made every effort to ensure that the functions and features under development are free from errors, it is possible that they could contain errors, inaccuracies, and omissions. Unless otherwise provided by valid agreement, we make no warranties of any kind, either implied or express, and exclude all liability for any loss or damage suffered in connection with the use of features and functions under development, to the maximum extent permitted by law, regardless of whether such loss or damage may have been foreseeable.
- d) We are not responsible for the accessibility, safety, accuracy, availability, legality, or completeness of information, advertising, commercial offers, products, services, and materials on third-party websites and third-party resources.

**Copyright © Quectel Wireless Solutions Co., Ltd. 2023. All rights reserved.**

# Revision History

Version	Date	Author	Note
-	2022-06-08	Ezail TAN	Creation of the document
1.0	2022-06-29	Ezail TAN	First official release
1.1	2022-09-09	Ezail TAN	Update test data.
1.2	2022-10-17	Aria CHU	Updated the IP rating.
2.0	2023-04-27	Joyful HUANG/ Lucky FENG/ David LIU/ Aria CHU	Updated all data and datasheet template.

**QUECTEL**

[www.quectel.com](http://www.quectel.com)