



# Antenna Datasheet

**Product OC:** YF0026LA

**Version:** 2.0

**Date:** 2024-01-18

**Status:** Released

**Product Name:** Wi-Fi FPC Antenna

**Key Features:**

Frequency Band: 2400–2500 MHz, 5150–5850 MHz, 5925–7125 MHz

Dimensions: 28.9 mm × 11 mm

Efficiency: Up to 80.08 %

RoHS Compliant

# Overview

Quectel Wi-Fi antenna covers 2.4 GHz, 5 GHz, and up to 7 GHz bands, fully satisfying customers' requirements for Wi-Fi 5, Wi-Fi 6, and Wi-Fi 6E/Wi-Fi 7. There are various antenna types, including built-in FPC/PCB antenna, ceramic patch antenna, and other external antennas of different shapes or sizes. The antenna performance meets the customers' demands for efficiency, gain, and radiation and ensures the superior experience of the customers' products in use.

# Contents

<b>Overview</b> .....	<b>1</b>
<b>Contents</b> .....	<b>2</b>
<b>1 Specification</b> .....	<b>3</b>
1.1. Electrical.....	3
1.2. Mechanical & Environmental .....	4
<b>2 Drawing</b> .....	<b>5</b>
<b>3 Detailed Performance</b> .....	<b>6</b>
3.1. S-Parameter Test .....	6
3.1.1. VSWR.....	6
3.1.2. Return Loss .....	7
3.2. Radiation Performance Test.....	8
3.2.1. Efficiency .....	8
3.2.2. Average Gain .....	9
3.2.3. Peak Gain.....	11
3.2.4. 3D & 2D Radiation Pattern.....	12
<b>4 Packaging</b> .....	<b>14</b>
<b>Contact Us</b> .....	<b>16</b>
<b>Legal Notices</b> .....	<b>17</b>
<b>Revision History</b> .....	<b>19</b>

# 1 Specification

Test Condition: On 1 mm FR4

## 1.1. Electrical

Electrical	
Frequency Range	2400–2500 MHz, 5150–5850 MHz, 5925–7125 MHz
Impedance	50 $\Omega$
Polarization	Linear
Radiation Pattern	Omni-directional

Specification	Band	Wi-Fi 2G	Wi-Fi 5G	Wi-Fi 7G
		2400 - 2500	5150 - 5850	5925 - 7125
Max. VSWR		1.8	2.3	1.9
Max. Return Loss (dB)		-11.2	-8.0	-10.4
AVG Eff. (%)		78.3	59.7	60.9
AVG Gain (dB)		-1.1	-2.3	-2.2
Max. Peak Gain (dBi)		2.5	4.2	5.2
VSWR		$\leq 2.3$		
Return Loss		$\leq -8$ dB		
Peak Gain		$\leq 5.2$ dBi		

## 1.2. Mechanical & Environmental

Mechanical	
Antenna Dimensions	28.9 mm × 11 mm
Material & Color	FPC & Black
Cable Type & Color & Length	Φ 1.13 & Black & 100 mm
Connector Type	IPEX MHF 4L
Mounting Type	Adhesive
Weight	Typ. 0.5 g
Environmental	
Operation Temperature	-40 °C to +85 °C
Storage Temperature	-40 °C to +85 °C
RoHS Compliant	Yes

# 2 Drawing

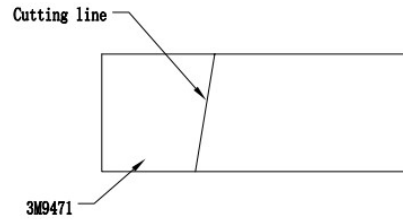
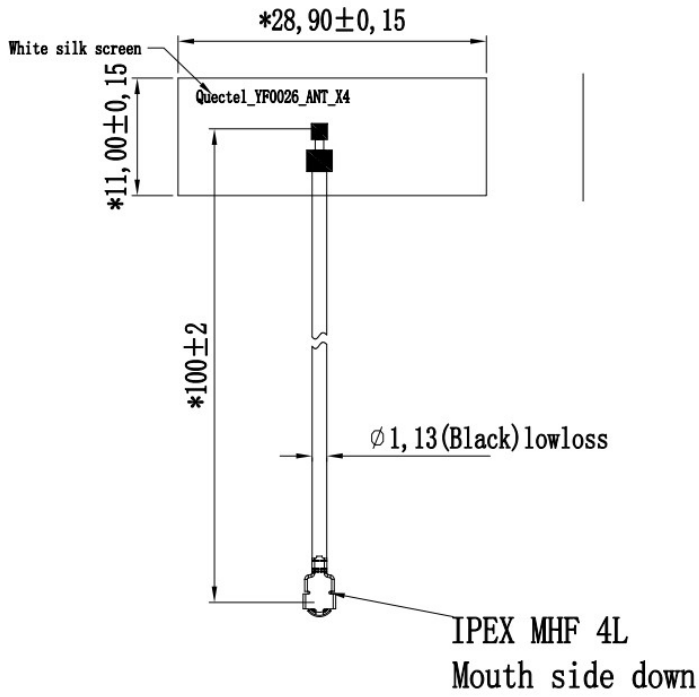

# 3 Detailed Performance

- Quectel Wireless Solutions (Changzhou) Co., Ltd.  
Address: No.8 Nanhu West Road, Wujin District, Changzhou City, Jiangsu Province, China 213100.

## 3.1. S-Parameter Test

### 3.1.1. VSWR

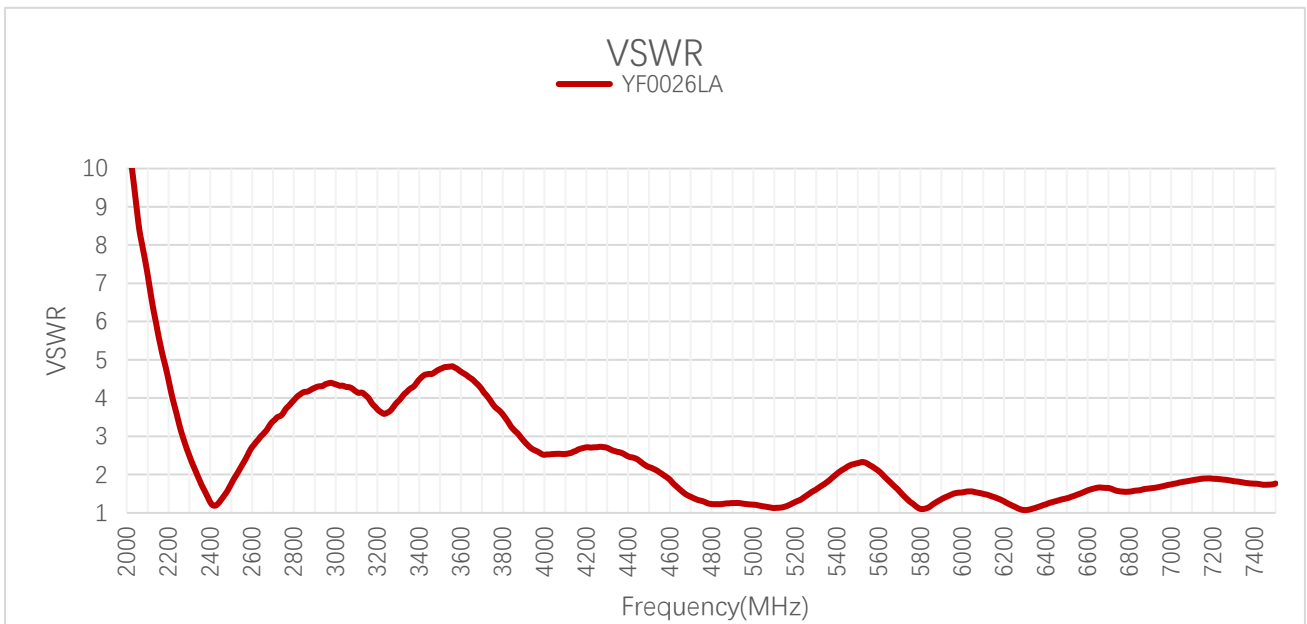

**VSWR**

<b>Frequency (MHz)</b>	<b>2400</b>	<b>2410</b>	<b>2420</b>	<b>2430</b>	<b>2440</b>	<b>2450</b>	<b>2460</b>	<b>2470</b>	<b>2480</b>	<b>2490</b>
<b>VSWR</b>	1.27	1.21	1.19	1.21	1.26	1.33	1.40	1.48	1.56	1.66
<b>Frequency (MHz)</b>	<b>2500</b>	<b>5150</b>	<b>5200</b>	<b>5250</b>	<b>5300</b>	<b>5350</b>	<b>5400</b>	<b>5450</b>	<b>5500</b>	<b>5550</b>
<b>VSWR</b>	1.76	1.16	1.28	1.43	1.61	1.80	2.02	2.21	2.30	2.27
<b>Frequency (MHz)</b>	<b>5600</b>	<b>5650</b>	<b>5700</b>	<b>5750</b>	<b>5800</b>	<b>5850</b>	<b>5900</b>	<b>5950</b>	<b>6000</b>	<b>6050</b>
<b>VSWR</b>	2.09	1.83	1.56	1.29	1.10	1.18	1.36	1.48	1.53	1.56

<b>Frequency (MHz)</b>	<b>6100</b>	<b>6150</b>	<b>6200</b>	<b>6250</b>	<b>6300</b>	<b>6350</b>	<b>6400</b>	<b>6450</b>	<b>6500</b>	<b>6550</b>
<b>VSWR</b>	1.50	1.42	1.30	1.16	1.07	1.13	1.22	1.31	1.38	1.48
<b>Frequency (MHz)</b>	<b>6600</b>	<b>6650</b>	<b>6700</b>	<b>6750</b>	<b>6800</b>	<b>6850</b>	<b>6900</b>	<b>6950</b>	<b>7000</b>	<b>7050</b>
<b>VSWR</b>	1.59	1.66	1.65	1.57	1.55	1.59	1.64	1.69	1.74	1.80
<b>Frequency (MHz)</b>	<b>7100</b>	<b>7150</b>								
<b>VSWR</b>	1.85	1.89								

**3.1.2. Return Loss**

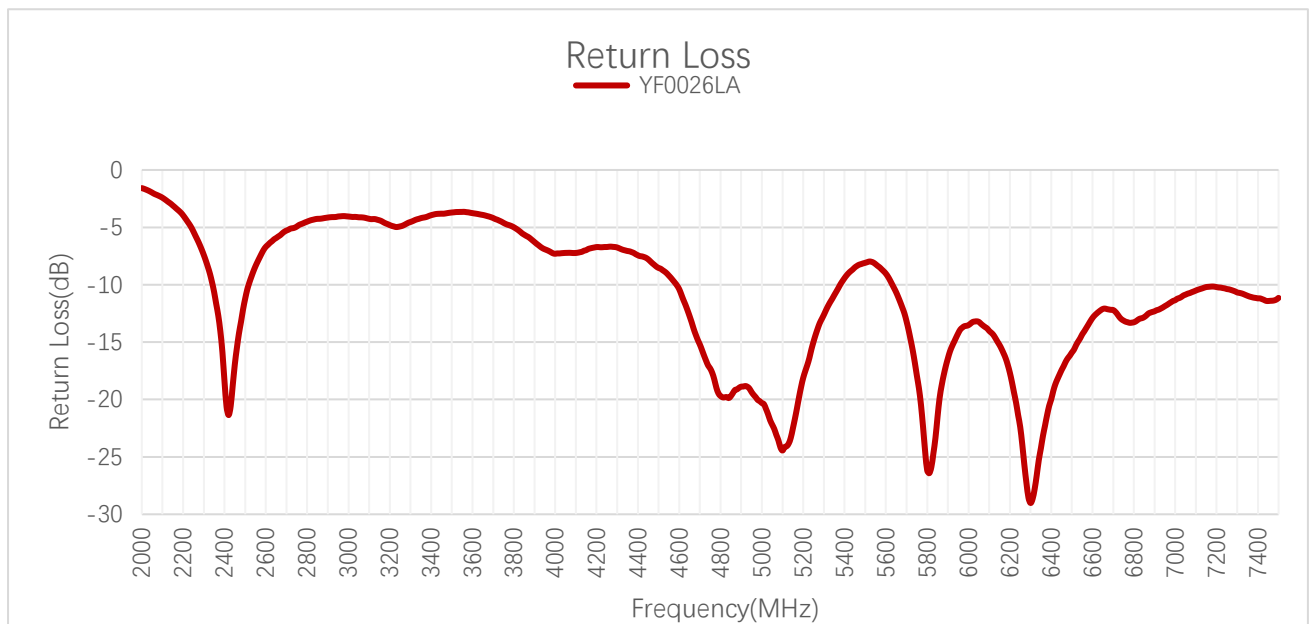

**Return Loss (dB)**

<b>Frequency (MHz)</b>	<b>2400</b>	<b>2410</b>	<b>2420</b>	<b>2430</b>	<b>2440</b>	<b>2450</b>	<b>2460</b>	<b>2470</b>	<b>2480</b>	<b>2490</b>
<b>Return Loss (dB)</b>	-18.39	-20.63	-21.36	-20.58	-18.75	-16.96	-15.51	-14.25	-13.23	-12.14
<b>Frequency (MHz)</b>	<b>2500</b>	<b>5150</b>	<b>5200</b>	<b>5250</b>	<b>5300</b>	<b>5350</b>	<b>5400</b>	<b>5450</b>	<b>5500</b>	<b>5550</b>
<b>Return Loss (dB)</b>	-11.23	-22.53	-18.12	-14.97	-12.62	-10.92	-9.42	-8.49	-8.09	-8.20
<b>Frequency (MHz)</b>	<b>5600</b>	<b>5650</b>	<b>5700</b>	<b>5750</b>	<b>5800</b>	<b>5850</b>	<b>5900</b>	<b>5950</b>	<b>6000</b>	<b>6050</b>



Return Loss (dB)	-9.03	-10.67	-13.18	-17.93	-26.18	-21.53	-16.42	-14.23	-13.52	-13.24
Frequency (MHz)	6100	6150	6200	6250	6300	6350	6400	6450	6500	6550
Return Loss (dB)	-14.02	-15.25	-17.67	-22.40	-29.02	-24.26	-19.99	-17.44	-15.91	-14.32
Frequency (MHz)	6600	6650	6700	6750	6800	6850	6900	6950	7000	7050
Return Loss (dB)	-12.89	-12.11	-12.20	-13.12	-13.27	-12.82	-12.31	-11.87	-11.35	-10.86
Frequency (MHz)	7100	7150								
Return Loss (dB)	-10.51	-10.20								

### 3.2. Radiation Performance Test

#### 3.2.1. Efficiency

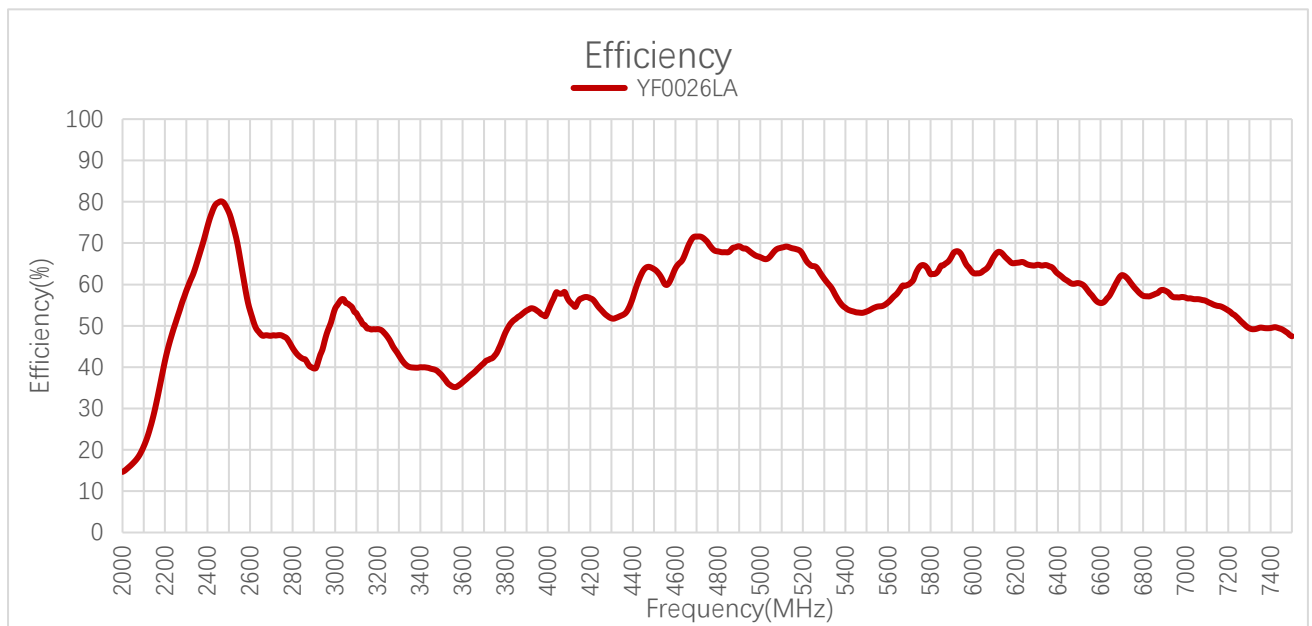

**Efficiency (%)**

<b>Frequency (MHz)</b>	<b>2400</b>	<b>2410</b>	<b>2420</b>	<b>2430</b>	<b>2440</b>	<b>2450</b>	<b>2460</b>	<b>2470</b>	<b>2480</b>	<b>2490</b>
<b>Efficiency (%)</b>	74.1	75.87	77.32	78.63	79.46	79.8	80.08	80.02	79.51	78.57
<b>Frequency (MHz)</b>	<b>2500</b>	<b>5150</b>	<b>5200</b>	<b>5250</b>	<b>5300</b>	<b>5350</b>	<b>5400</b>	<b>5450</b>	<b>5500</b>	<b>5550</b>
<b>Efficiency (%)</b>	77.51	68.76	67.23	64.44	61.42	57.71	54.36	53.27	53.46	54.64
<b>Frequency (MHz)</b>	<b>5600</b>	<b>5650</b>	<b>5700</b>	<b>5750</b>	<b>5800</b>	<b>5850</b>	<b>5900</b>	<b>5950</b>	<b>6000</b>	<b>6050</b>
<b>Efficiency (%)</b>	55.64	58.28	60.09	64.34	62.53	64.54	66.83	66.78	62.83	63.35
<b>Frequency (MHz)</b>	<b>6100</b>	<b>6150</b>	<b>6200</b>	<b>6250</b>	<b>6300</b>	<b>6350</b>	<b>6400</b>	<b>6450</b>	<b>6500</b>	<b>6550</b>
<b>Efficiency (%)</b>	66.86	66.74	65.21	65	64.73	64.61	62.59	60.68	60.3	57.88
<b>Frequency (MHz)</b>	<b>6600</b>	<b>6650</b>	<b>6700</b>	<b>6750</b>	<b>6800</b>	<b>6850</b>	<b>6900</b>	<b>6950</b>	<b>7000</b>	<b>7050</b>
<b>Efficiency (%)</b>	55.52	58	62.25	59.85	57.27	57.53	58.58	56.9	56.82	56.45
<b>Frequency (MHz)</b>	<b>7100</b>	<b>7150</b>								
<b>Efficiency (%)</b>	55.91	54.82								

**3.2.2. Average Gain**

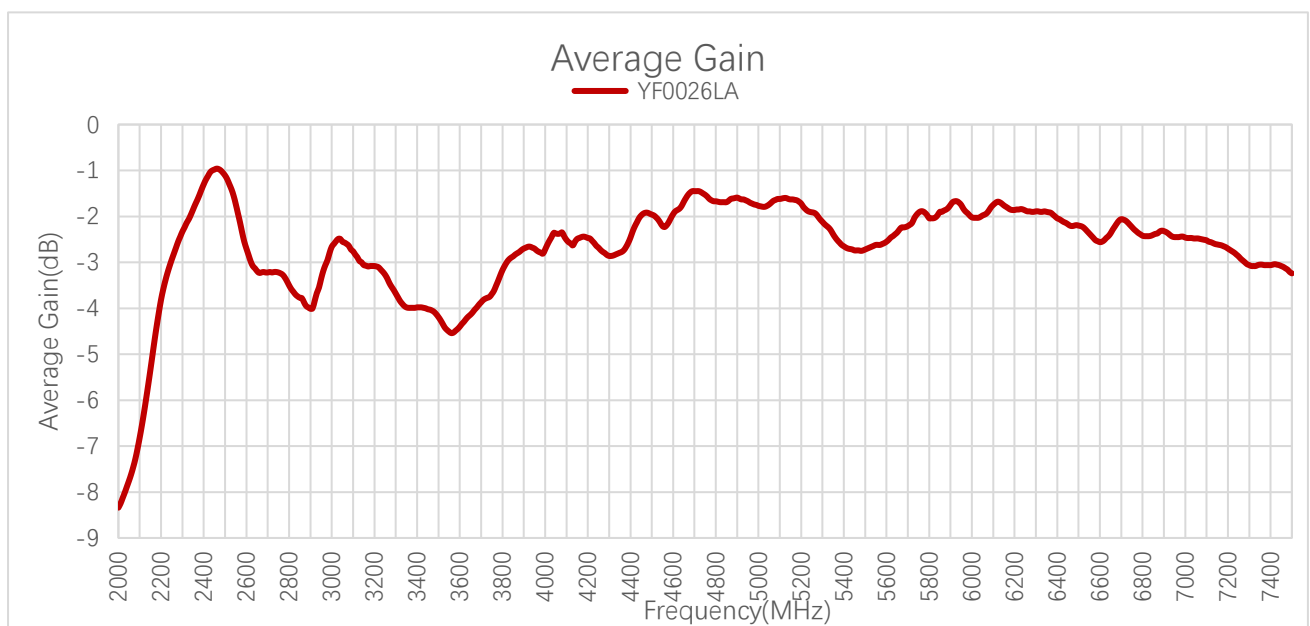

**Average Gain (dB)**

<b>Frequency (MHz)</b>	<b>2400</b>	<b>2410</b>	<b>2420</b>	<b>2430</b>	<b>2440</b>	<b>2450</b>	<b>2460</b>	<b>2470</b>	<b>2480</b>	<b>2490</b>
<b>Average Gain (dB)</b>	-1.3	-1.2	-1.12	-1.04	-1	-0.98	-0.96	-0.97	-1	-1.05
<b>Frequency (MHz)</b>	<b>2500</b>	<b>5150</b>	<b>5200</b>	<b>5250</b>	<b>5300</b>	<b>5350</b>	<b>5400</b>	<b>5450</b>	<b>5500</b>	<b>5550</b>
<b>Average Gain (dB)</b>	-1.11	-1.63	-1.72	-1.91	-2.12	-2.39	-2.65	-2.74	-2.72	-2.62
<b>Frequency (MHz)</b>	<b>5600</b>	<b>5650</b>	<b>5700</b>	<b>5750</b>	<b>5800</b>	<b>5850</b>	<b>5900</b>	<b>5950</b>	<b>6000</b>	<b>6050</b>
<b>Average Gain (dB)</b>	-2.55	-2.35	-2.21	-1.92	-2.04	-1.9	-1.75	-1.75	-2.02	-1.98
<b>Frequency (MHz)</b>	<b>6100</b>	<b>6150</b>	<b>6200</b>	<b>6250</b>	<b>6300</b>	<b>6350</b>	<b>6400</b>	<b>6450</b>	<b>6500</b>	<b>6550</b>
<b>Average Gain (dB)</b>	-1.75	-1.76	-1.86	-1.87	-1.89	-1.9	-2.04	-2.17	-2.2	-2.37
<b>Frequency (MHz)</b>	<b>6600</b>	<b>6650</b>	<b>6700</b>	<b>6750</b>	<b>6800</b>	<b>6850</b>	<b>6900</b>	<b>6950</b>	<b>7000</b>	<b>7050</b>
<b>Average Gain (dB)</b>	-2.56	-2.37	-2.06	-2.23	-2.42	-2.4	-2.32	-2.45	-2.46	-2.48
<b>Frequency (MHz)</b>	<b>7100</b>	<b>7150</b>								
<b>Average Gain (dB)</b>	-2.52	-2.61								

**3.2.3. Peak Gain**

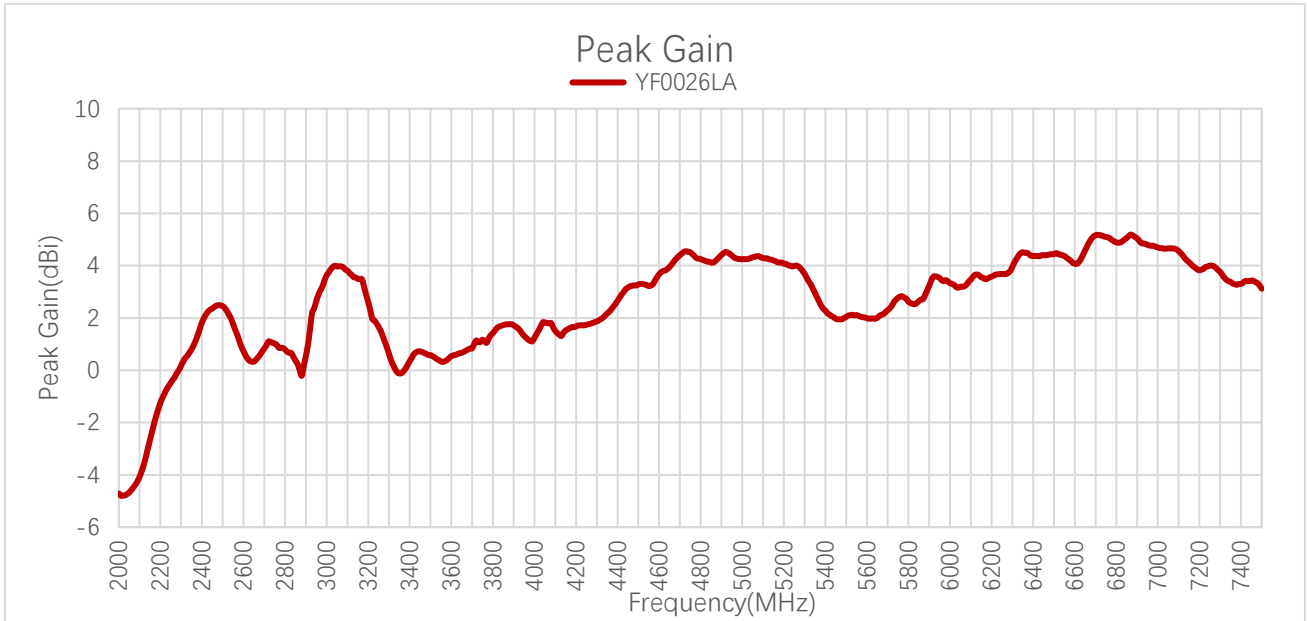

**Peak Gain (dBi)**

<b>Frequency (MHz)</b>	<b>2400</b>	<b>2410</b>	<b>2420</b>	<b>2430</b>	<b>2440</b>	<b>2450</b>	<b>2460</b>	<b>2470</b>	<b>2480</b>	<b>2490</b>
<b>Peak Gain (dBi)</b>	1.83	2	2.14	2.25	2.32	2.36	2.43	2.47	2.49	2.48
<b>Frequency (MHz)</b>	<b>2500</b>	<b>5150</b>	<b>5200</b>	<b>5250</b>	<b>5300</b>	<b>5350</b>	<b>5400</b>	<b>5450</b>	<b>5500</b>	<b>5550</b>
<b>Peak Gain (dBi)</b>	2.45	4.2	4.08	3.99	3.69	2.96	2.28	1.97	2.04	2.11
<b>Frequency (MHz)</b>	<b>5600</b>	<b>5650</b>	<b>5700</b>	<b>5750</b>	<b>5800</b>	<b>5850</b>	<b>5900</b>	<b>5950</b>	<b>6000</b>	<b>6050</b>
<b>Peak Gain (dBi)</b>	1.99	2.01	2.3	2.77	2.62	2.65	3.24	3.53	3.33	3.2
<b>Frequency (MHz)</b>	<b>6100</b>	<b>6150</b>	<b>6200</b>	<b>6250</b>	<b>6300</b>	<b>6350</b>	<b>6400</b>	<b>6450</b>	<b>6500</b>	<b>6550</b>
<b>Peak Gain (dBi)</b>	3.47	3.56	3.58	3.68	3.96	4.51	4.37	4.4	4.44	4.37
<b>Frequency (MHz)</b>	<b>6600</b>	<b>6650</b>	<b>6700</b>	<b>6750</b>	<b>6800</b>	<b>6850</b>	<b>6900</b>	<b>6950</b>	<b>7000</b>	<b>7050</b>
<b>Peak Gain (dBi)</b>	4.08	4.58	5.16	5.1	4.89	5.06	5.04	4.8	4.7	4.66

Frequency (MHz)	7100	7150							
Peak Gain (dBi)	4.56	4.13							

**3.2.4. 3D & 2D Radiation Pattern**

- Test Condition: On 1 mm FR4
- Test Chamber: GL-S-1

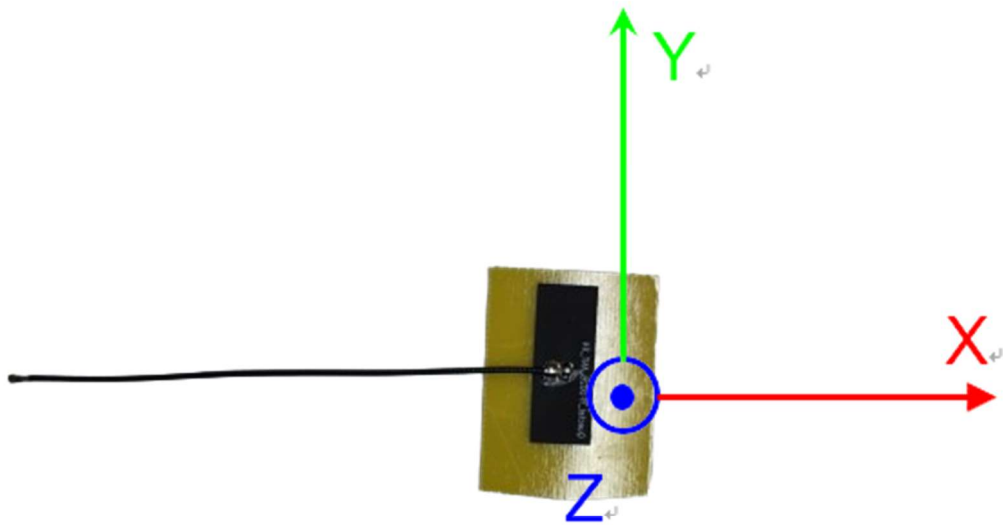

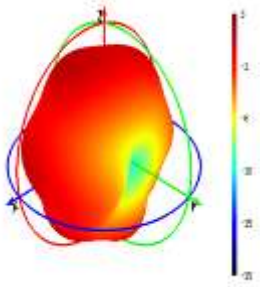
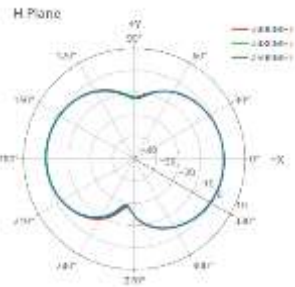
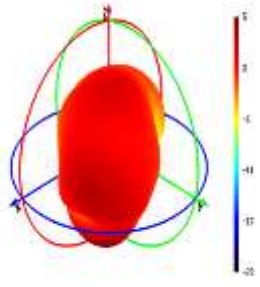
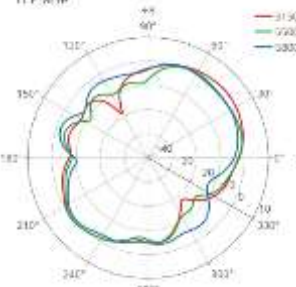
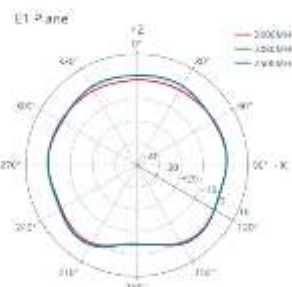
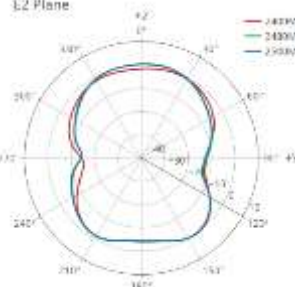
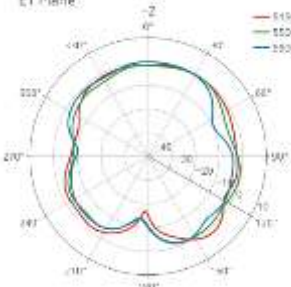
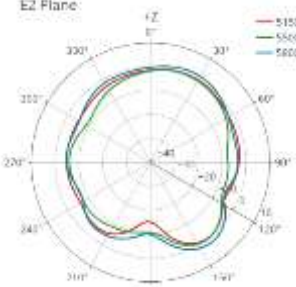
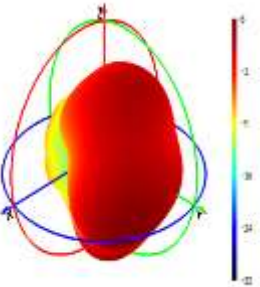
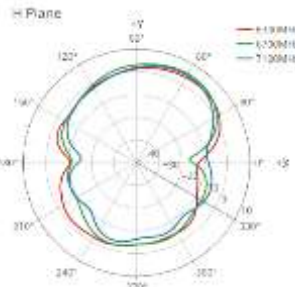
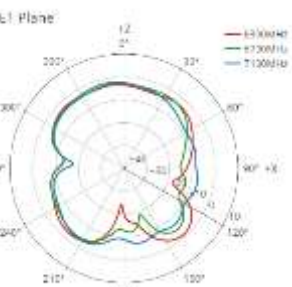
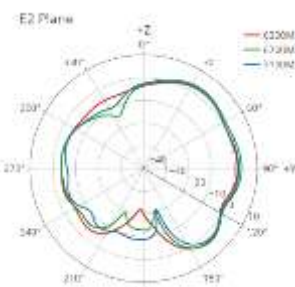
2480 MHz		5150 MHz	
			
			
6700 MHz			
			
			

# 4 Packaging

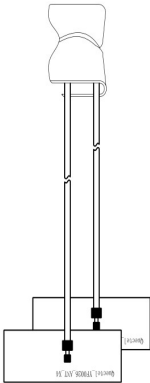
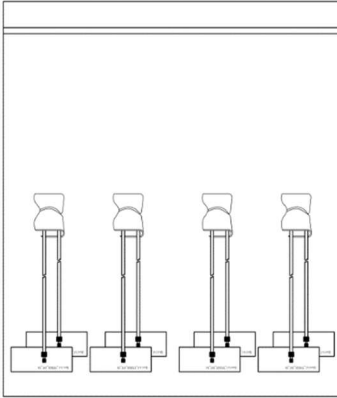
Step	Packaging Picture / 2D Picture	Description
1	 <p>50PCS/bale</p>	50 products in a bundle
2	 <p>200PCS/bag</p>	200 pcs antenna products in a PE bag. (200 PCS / PE Bag)

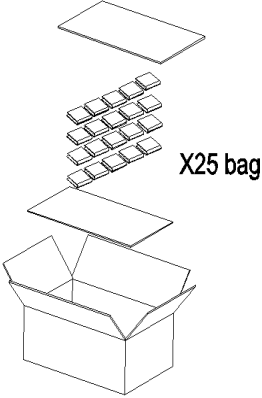
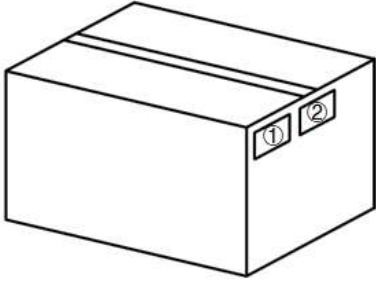
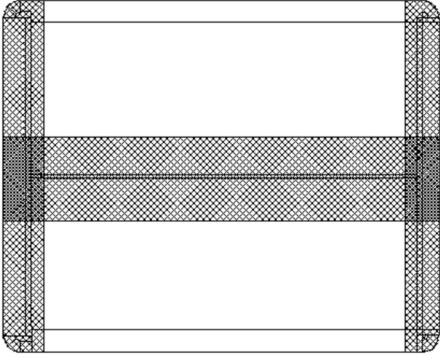
<p>3</p>		<p>(25 PE Bags / Carton Box) (5000 PCS Antennas / Carton Box) Estimated quantity Products that cannot fill the entire carton box are packed in a suitable size carton box. <u>Carton Size:</u> <u>L×W × H = 390 × 275 × 300 mm</u></p>
<p>4</p>		<p><b>Position for Attaching Labels</b> ① Carton Label ② Quality Label</p>
<p>5</p>		<p><b>Sealing Cartons</b> “工” type sealing cartons</p>
<p>Note</p>	<p>The initial packaging method described above is for reference only, and the final actual packaging method shall be subject to the actual shipping packaging.</p>	



# Contact Us

**At Quectel, our aim is to provide timely and comprehensive services to our customers. If you require any assistance, please contact our headquarters:**

**Quectel Wireless Solutions Co., Ltd.**

Building 5, Shanghai Business Park Phase III (Area B), No.1016 Tianlin Road, Minhang District, Shanghai 200233, China

Tel: +86 21 5108 6236

Email: [info@quectel.com](mailto:info@quectel.com)

**Or our local offices. For more information, please visit:**

<http://www.quectel.com/support/sales.htm>.

**For technical support, or to report documentation errors, please visit:**

<http://www.quectel.com/support/technical.htm>.

Or email us at: [support@quectel.com](mailto:support@quectel.com).

# Legal Notices

We offer information as a service to you. The provided information is based on your requirements and we make every effort to ensure its quality. You agree that you are responsible for using independent analysis and evaluation in designing intended products, and we provide reference designs for illustrative purposes only. Before using any hardware, software or service guided by this document, please read this notice carefully. Even though we employ commercially reasonable efforts to provide the best possible experience, you hereby acknowledge and agree that this document and related services hereunder are provided to you on an “as available” basis. We may revise or restate this document from time to time at our sole discretion without any prior notice to you.

## Use and Disclosure Restrictions

### License Agreements

Documents and information provided by us shall be kept confidential, unless specific permission is granted. They shall not be accessed or used for any purpose except as expressly provided herein.

### Copyright

Our and third-party products hereunder may contain copyrighted material. Such copyrighted material shall not be copied, reproduced, distributed, merged, published, translated, or modified without prior written consent. We and the third party have exclusive rights over copyrighted material. No license shall be granted or conveyed under any patents, copyrights, trademarks, or service mark rights. To avoid ambiguities, purchasing in any form cannot be deemed as granting a license other than the normal non-exclusive, royalty-free license to use the material. We reserve the right to take legal action for noncompliance with abovementioned requirements, unauthorized use, or other illegal or malicious use of the material.

### Trademarks

Except as otherwise set forth herein, nothing in this document shall be construed as conferring any rights to use any trademark, trade name or name, abbreviation, or counterfeit product thereof owned by Quectel or any third party in advertising, publicity, or other aspects.

### Third-Party Rights

This document may refer to hardware, software and/or documentation owned by one or more third parties (“third-party materials”). Use of such third-party materials shall be governed by all restrictions and obligations applicable thereto.

We make no warranty or representation, either express or implied, regarding the third-party materials, including but not limited to any implied or statutory, warranties of merchantability or fitness for a particular purpose, quiet enjoyment, system integration, information accuracy, and non-infringement of any third-party intellectual property rights with regard to the licensed technology or use thereof. Nothing herein constitutes a representation or warranty by us to either develop, enhance, modify, distribute, market, sell, offer for sale, or otherwise maintain production of any our products or any other hardware, software, device, tool, information, or product. We moreover disclaim any and all warranties arising from the course of dealing or usage of trade.

## Privacy Policy

To implement module functionality, certain device data are uploaded to Quectel's or third-party's servers, including carriers, chipset suppliers or customer-designated servers. Quectel, strictly abiding by the relevant laws and regulations, shall retain, use, disclose or otherwise process relevant data for the purpose of performing the service only or as permitted by applicable laws. Before data interaction with third parties, please be informed of their privacy and data security policy.

## Disclaimer

- a) We acknowledge no liability for any injury or damage arising from the reliance upon the information.
- b) We shall bear no liability resulting from any inaccuracies or omissions, or from the use of the information contained herein.
- c) While we have made every effort to ensure that the functions and features under development are free from errors, it is possible that they could contain errors, inaccuracies, and omissions. Unless otherwise provided by valid agreement, we make no warranties of any kind, either implied or express, and exclude all liability for any loss or damage suffered in connection with the use of features and functions under development, to the maximum extent permitted by law, regardless of whether such loss or damage may have been foreseeable.
- d) We are not responsible for the accessibility, safety, accuracy, availability, legality, or completeness of information, advertising, commercial offers, products, services, and materials on third-party websites and third-party resources.

**Copyright © Quectel Wireless Solutions Co., Ltd. 2024. All rights reserved.**

# Revision History

Version	Date	Author	Note
-	2022-08-18	Sly LIU/ Lucky FENG	Creation of the document
1.0	2023-01-15	Sly LIU/ Lucky FENG	First official release
2.0	2024-01-18	Sly LIU/ Lucky FENG/ David LIU/ Rainey LIAO	Numerous changes were made to this document. It should be read in its entirety.

**QUECTEL**

[www.quectel.com](http://www.quectel.com)